

MULTIPLE PUMPS – SINGLE ELEMENTS

MULTIPLE PUMPS CATALOGUE - Introduction

The catalogue is mainly composed in two sections, reflecting the possible supply manners:

- Single elements
Dimensions, characteristics and codification of the single elements composing the multiple pumps
- Assembled pumps
Dimensions, characteristics and codes of assembled pumps

The variety of variants allows a high number of possible alternatives. Both the sections try to give an instrument to consult easily to create the ideal solution.

ASSEMBLED PUMPS

In the following section it's represented how to compose the assembled multiple pumps. For each driving pump, identified by the connection flange, two or more pages are prepared as showed in the image below. In particular you may find:

1. Three-dimensional representation of the assembled pump typology
2. Different coupling solutions
3. Special solutions
4. Dimensional and features summary table.
5. Product Code structure and corresponding **purchasing code** starting from the specific features that can be chosen from the possible solution
6. Displacement for the primary pump.

POMPA MULTIPLA XV-1
BASE # 30

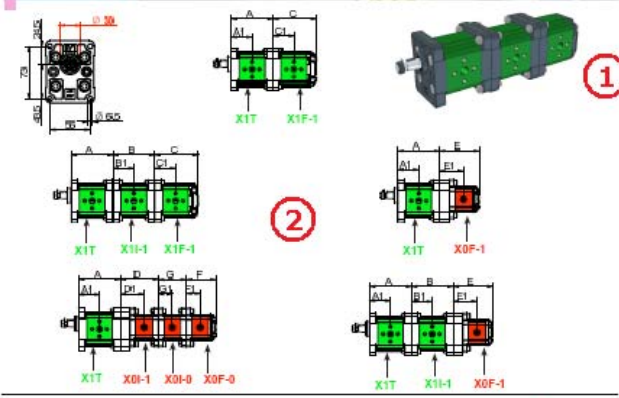

TIPO	Cilindrata Cm³/giro	A	A1	B	B1	C	C1	P1	P2	Regime Max g/min	Regime Max g/hora
XV-1/1.0	0.91	74.5	37.5	74.5	37.5	75	37.5	240	200	700	5000
XV-1/1.5	1.37	75.5	37.6	75.5	37.6	75	37.6	250	200	700	5000
XV-1/2.0	1.86	77	38.0	77	38.0	80.5	38.0	250	200	700	5000
XV-1/2.5	2.36	79	39.0	79	39.0	82.5	39.0	250	200	700	5000
XV-1/3.0	2.86	81	40.0	81	40.0	84.5	40.0	250	200	700	5000
XV-1/3.5	3.37	83	41.0	83	41.0	86	41.0	250	200	700	5000
XV-1/4.0	3.88	85	42.0	85	42.0	88.5	42.0	250	200	700	5000
XV-1/4.5	4.39	87	43.0	87	43.0	90.5	43.0	250	200	700	5000
XV-1/5.0	4.91	89	44.0	89	44.0	92.5	44.0	250	200	700	5000
XV-1/5.5	5.43	91	45.0	91	45.0	94.5	45.0	250	200	700	5000
XV-1/6.0	5.95	93	46.0	93	46.0	96.5	46.0	250	200	700	5000
XV-1/6.5	6.48	95	47.0	95	47.0	98.5	47.0	250	200	700	5000
XV-1/7.0	7.01	97	48.0	97	48.0	100.5	48.0	250	200	700	5000
XV-1/7.5	7.55	99	49.0	99	49.0	102.5	49.0	250	200	700	5000
XV-1/8.0	8.09	101	50.0	101	50.0	104.5	50.0	250	200	700	5000
XV-1/8.5	8.64	103	51.0	103	51.0	106.5	51.0	250	200	700	5000
XV-1/9.0	9.19	105	52.0	105	52.0	108.5	52.0	250	200	700	5000
XV-1/9.5	9.75	107	53.0	107	53.0	110.5	53.0	250	200	700	5000
XV-1/10.0	10.31	109	54.0	109	54.0	112.5	54.0	250	200	700	5000

POMPA MULTIPLA XV-1
BASE # 32 Sagomata - TIPO "BH"

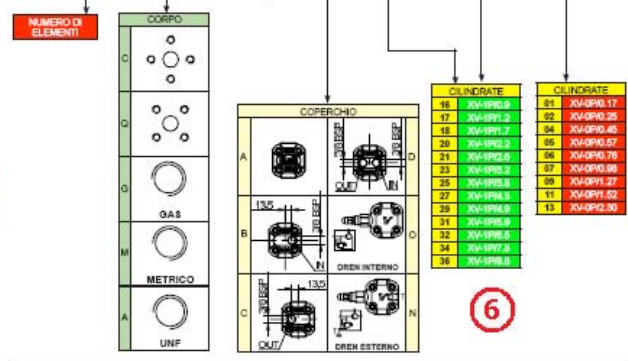
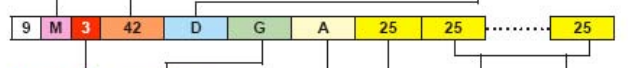
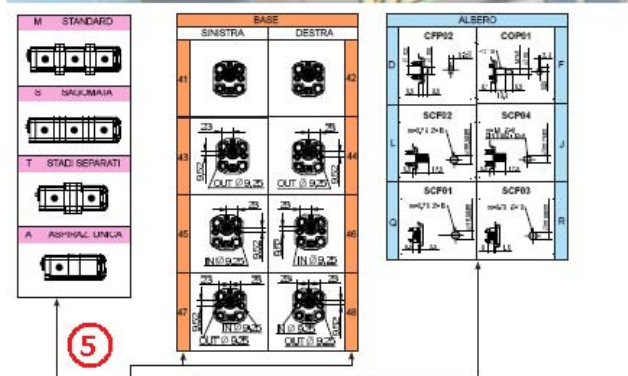

MULTIPLE PUMPS – SINGLE ELEMENTS

DIMENSIONAL CHECK

The correct dimensioning of a multiple pump requires an opportune verification on the mechanical resistance considering the specific working conditions. Therefore **IT IS RECOMMENDED** to do a dimensional check during the engineering phase in order to have a coherent choice with the real system capabilities.

The required data for the verification are mainly the **displacements** and **the working pressures** of each element. Starting from these basic data it is possible to find out the torque that is created on each driving shaft, both analytically than graphically.

ANALYTICAL PROCEDURE

To calculate analytically the transmitted torque, we assume that

- v_i = element displacement expressed in cc/rev.
- Δp = pressure difference between inlet and outlet expressed in bar
- η_m = mechanical efficiency that we can assume as 0.9

The transmitted torque is obtained by this simple equation.

$$T_{elem} = \frac{v_i \times \Delta p}{20 \times \pi \times \eta_m}$$

GRAPHICAL PROCEDURE

The identification of the torque transmitted by each single element can be obtained graphically starting from the below tables. When the Pressure/Torque table corresponding to the dimensional group is identified, choose the line on the graphic regarding the element displacement. Starting from the outlet pressure, get the corresponding torque.

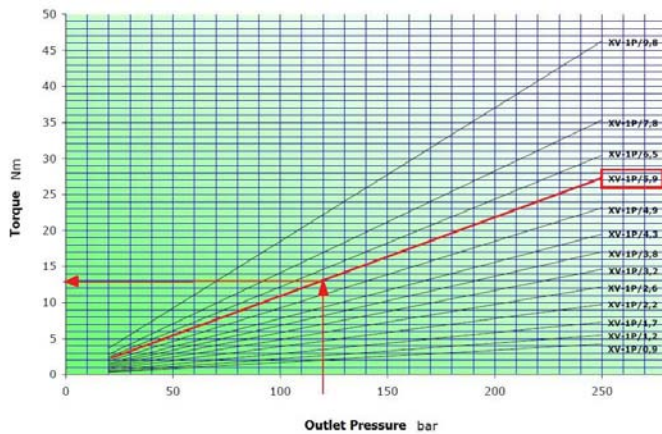

The verification require to compare the obtained torque value with the one recommended for each typology of connection or connecting shaft.

To each element, starting from the final one, the torque coming from the previous ones must be added, using the following scheme:

FINAL ELEMENT VERIFICATION	$T_{elem_fin} \leq T_{fin}$
INTERMEDIATE ELEMENT VERIFICATION	$T_{elem_int} + T_{elem_int_preced} + T_{elem_fin} \leq T_{int}$
DRIVING ELEMENT VERIFICATION	$T_{elem_prim} + \dots + T_{elem_int} + \dots + T_{elem_fin} \leq T_{prim}$

MULTIPLE PUMPS – SINGLE ELEMENTS

The recommended values are summarized in the following tables:

TORQUES ALLOWED ON DRIVING PUMP SHAFT:

	SHAFT [IDENTIFIER] - CODE - DESCRIPTION	T Max [Nm]
XV-0P	[A] - CI001 - Parallel \varnothing 7 - M 7x1 - key thk sp.2	2.1
	[B] - CF001 - Milled shank \varnothing 7 - sp. 5	9,2
	[F] - CF005 - Milled shank \varnothing 7 - sp.4,5 L = 9	8.4
XV-1P	[A] - CI001 - Parallel \varnothing 12 - M10x1 - key thk. 3	25,8
	[B] - CI002 - Parallel \varnothing 12.7 - key thk. 3.2 (SAE)	32,8
	[C] - CF001 - Milled shank \varnothing 10 - thk.5 ("BH" Standard German)	13,8
	[D] - CF002 - Milled shank \varnothing 10 - thk.5	13,8
	[E] - CF003 - Milled shank \varnothing 11 - thk.6.63 (SAE)	25,8
	[F] - CO001 - Tapered 1:8 - \varnothing 10 - M7x1 - key thk.2.4	43.1
	[G] - CO002 - Tapered 1:8 - \varnothing 14 - M10x1 - key thk.3	119,8
	[I] - CO004 - Tapered 1:8 - \varnothing 12.7 - 5/16" 24UNF-2A - key thk.3.2 (SAE)	90,4
	[J] - SCF04 - Splined \varnothing 11.7 - z=6, H=17.5, m=1.6, DIN 5482 12x9	22,6
	[K] - SCF05 - Splined \varnothing 12.344, z=9, H=19, SAE J498 9T 20/40DB	32,2
	[L] - SCF02 - Splined \varnothing 11.9, z=15, H=17.5, m=0.75	42,8
	[O] - CO002+HK - Tapered 1:8 - \varnothing 14 - M10x1, HK 14-12, key thk.3	119,8
	[P] - CI001+HK - Parallel \varnothing 12 - M10x1 with bearing HK 14-12 - key thk.3	25,8
	[Q] - SCF01 - Splined \varnothing 11.9, z=15, H=9, m=0.75	42,8
	[R] - SCF03 - Splined \varnothing 11.9, z=15, H=9, m=0.75	42,8
	XV-2P	[A] - CI001 - Parallel \varnothing 15 - M6x1 - key thk.4
[B] - CI002 - Parallel \varnothing 15.875 – 1/4"28-UNF key thk.4 (SAE A)		67.5
[C] - CF001 - Miled shank \varnothing 15 - thk.8 ("BH" Standard German)		60.5
[E] - CO001 - Tapered 1:8 - \varnothing 17,4 - M12x1,5 - key thk.4		233.2
[F] - CO002 - Tapered 1:5 - \varnothing 17,4 - M12x1,5 - key thk.3		233.2
[G] - SCF02 - Splined \varnothing 16,5 - z=9, H=13, m=1.6 DIN 5482 17x14		86.1
[H] - SCF03 - Splined \varnothing 16.5 - z=9, H=18,8, m=1,6 DIN 5482 17x14		86.1
[I] - SCF04 - Splined \varnothing 15.456 z=9, H=22.5, SAE J498 9T 16/32DP		67.1
[K] - SCF05 - Splined \varnothing 16.5 z=9 H=8,1 m=1.6 DIN 5482 17x14		86.2
[L] - SCF01- Splined \varnothing 16.5 z=9 H=9,2 m=1.6 DIN 5482 17x14		86.2
[M] - CO001 - Tapered 1:8 - \varnothing 17,4 - M12x1,5 - key thk.3,2		233.2
XV-3P	[A] - CO001 - Tapered 1:8 - \varnothing 22 - M14x1.5 - key thk.4	482
	[B] - CI001 - Parallel \varnothing 20 - M8 - key thk.5	181
	[C] - SCF03 - Splined \varnothing 21.5, z=13, H=25, m=1,6	223
	[H] - CI004 - Parallel \varnothing 22.225– 1/4"28-UNF key thk.6.35 (SAE B)	180
	[I] - SCF04 - Splined \varnothing 21.8059, z=13, H=25, SAE J498 9T 16/32DP	264

MULTIPLE PUMPS – SINGLE ELEMENTS

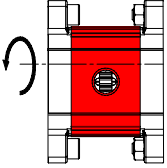
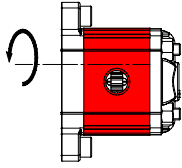
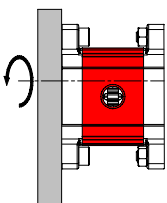
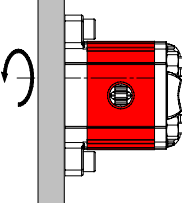
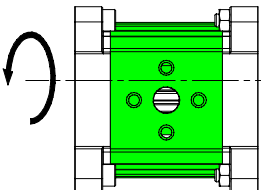
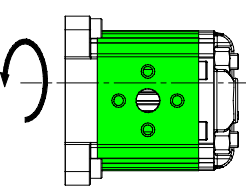
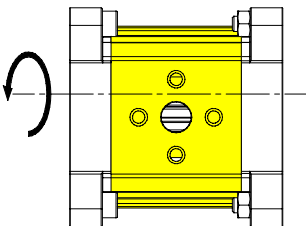
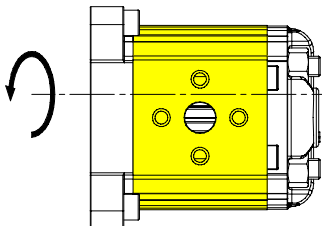
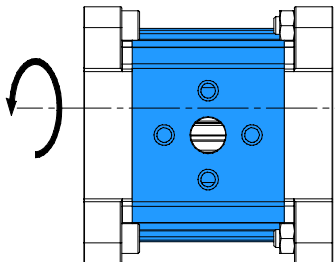
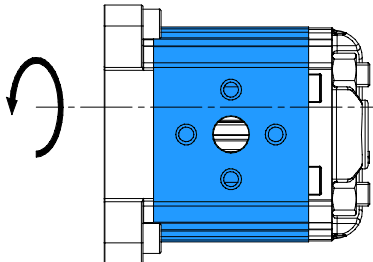

TORQUES ALLOWED ON FINAL AND INTERMEDIATE PUMP SHAFT:

Composition	Intermediate Pump Couple T_{int}	Final Pump Couple T_{fin}
0P + 0P	 3,7 Nm	 3,7 Nm
1P + 0P 2P + 0P 3P + 0P	 2,1 Nm	 2,1 Nm
1P + 1P 2P + 1P 3P + 1P	 42,8 Nm	 42,8 Nm
2P + 2P 3P + 3P	 86,2 Nm	 86,2 Nm
3P + 3P	 332 Nm	 332 Nm

MULTIPLE PUMPS – SINGLE ELEMENTS

Example of quadruple pump verification with primary taper shaft COP02:

Element typology	Displacement	Working Pressure
Driving	22 cc	150 bar
Intermediate 1	5.9 cc	120 bar
Intermediate 2	5.9 cc	100 bar
Final	1.2 cc	100 bar

Consequently through the calculation or graphical analysis

Motive Torque
58.39 Nm
12.53 Nm
10.44 Nm
2.12 Nm

The verification therefore is, starting from the final element:

Final element

$$T_{elem_fin} \leq T_{fin} \quad 2.12 \text{ Nm} < \quad \text{OK}$$

Intermediate Element 2

$$T_{elem_int} + T_{elem_int_preced} + T_{elem_fin} \leq T_{int} \quad 2.12 + 10.44 \text{ Nm} = 12.56 \text{ Nm} < \quad \text{OK}$$

Intermediate Element 1

$$T_{elem_int} + T_{elem_int_preced} + T_{elem_fin} \leq T_{int} \quad 12.56 + 12.53 \text{ Nm} = 25.09 \text{ Nm} < \quad \text{OK}$$

Driving Element

$$T_{elem_prim} + \dots + T_{elem_int} + \dots + T_{elem_fin} \leq T_{prim} \quad 25.09 + 58.39 \text{ Nm} = 83.48 \text{ Nm} < 233.2 \text{ Nm} \quad \text{OK}$$

General Notes:

For assemblies with a coupling, you should choose one as balanced as possible in order to reduce the vibrations and dynamic stresses to which the pump shaft may be subject.

Always make sure that the torque applied is less than or equal to the admissible torque of the shaft.

Do not apply a direct axial or radial load on the pump shaft; if necessary, use suitable supports.

Always use well-filtered oils containing no water or other emulsifying substance.

Never run the pump with oil and air solutions.

For pumps with outlets on the flange, it is recommended not to exceed a flow rate of

4 l/min	XV-0P
20 l/min.	XV-1P
35 l/min	XV-2P

MULTIPLE PUMP XV-2

ø 50 "BH" Body-Shaped FLANGE

XV-2

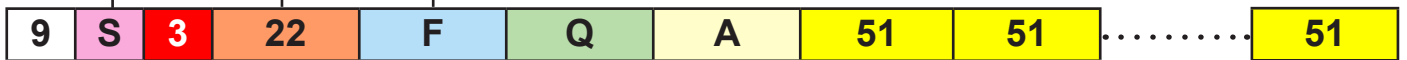
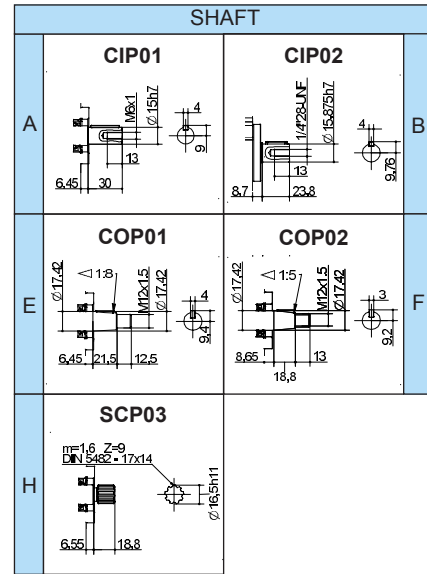
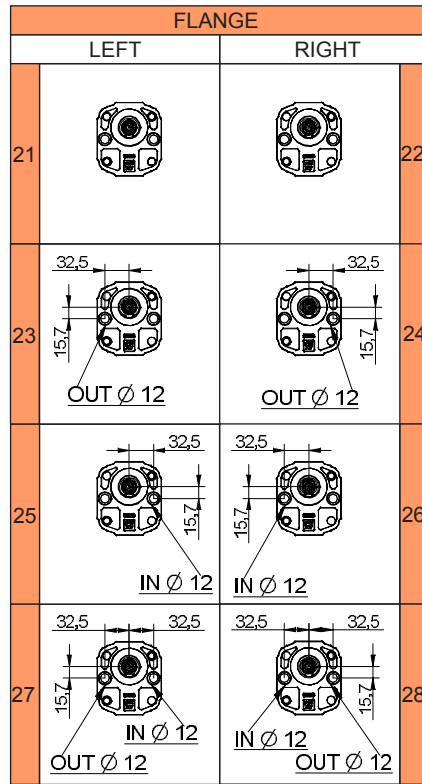
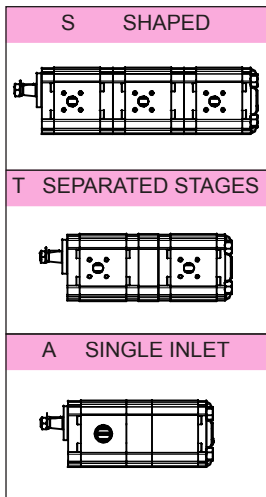

NUMBER OF ELEMENTS

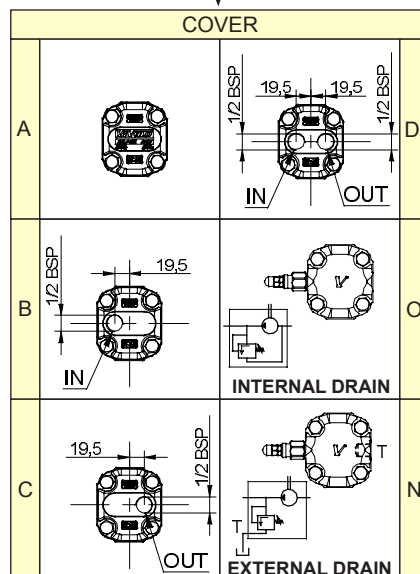
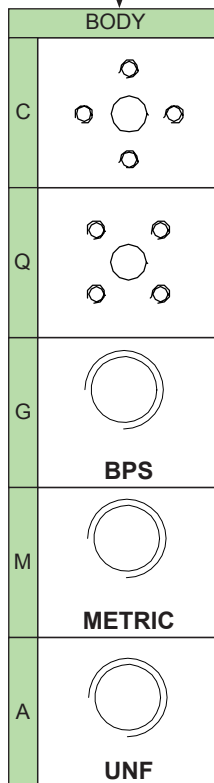

DISPLACEMENT	
41	XV-2P/ 4
43	XV-2P/ 6
45	XV-2P/ 9
47	XV-2P/ 11
49	XV-2P/14
51	XV-2P/17
53	XV-2P/19
55	XV-2P/22
57	XV-2P/26
59	XV-2P/30
61	XV-2P/34
63	XV-2P/40

DISPLACEMENT	
01	XV-0P/0.17
02	XV-0P/0.25
04	XV-0P/0.45
05	XV-0P/0.57
06	XV-0P/0.76
07	XV-0P/0.98
09	XV-0P/1.27
11	XV-0P/1.52
13	XV-0P/2.30
16	XV-1P/0.9
17	XV-1P/1.2
18	XV-1P/1.7
20	XV-1P/2.2
21	XV-1P/2.6
23	XV-1P/3.2
25	XV-1P/3.8
27	XV-1P/4.3
29	XV-1P/4.9
31	XV-1P/5.9
32	XV-1P/6.5
34	XV-1P/7.8
36	XV-1P/9.8

MULTIPLE PUMP XV-2

ø 50 "HY" Body-Shaped FLANGE

XV-2

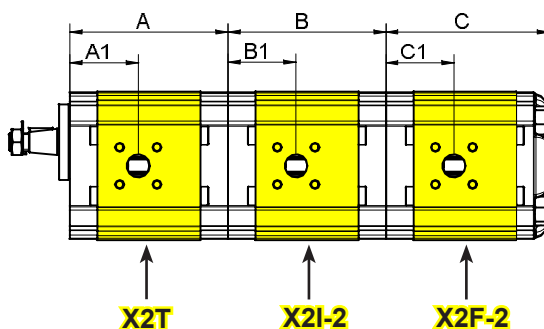
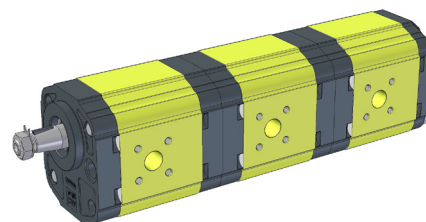
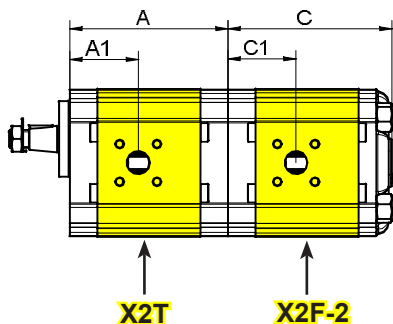
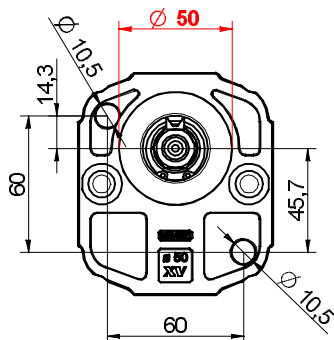

SEPARATED STAGES

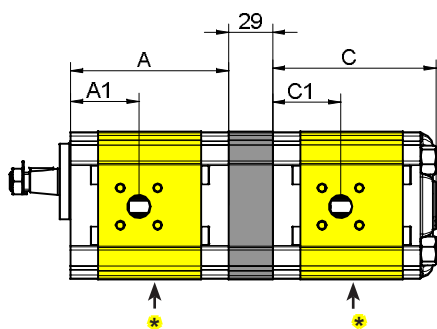

SINGLE INLET

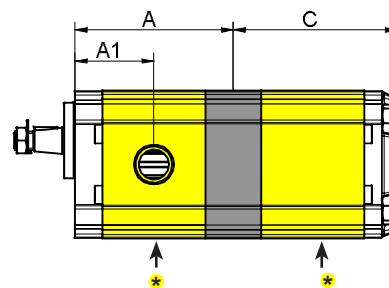

* = SPECIAL ELEMENT, please contact our customer service for details.

TYPE	Displacement cc/rev	A mm	A1 mm	B mm	B1 mm	C mm	C1 mm	P1 bar	P3 bar	Min speed rpm	Max speed rpm
XV-2 / 4	4,20	83,4	38,6	83,4	38,6	87,2	38,6	260	300	700	4000
XV-2 / 6	6,00	86,4	38,6	86,4	38,6	90,2	38,6	260	300	700	3500
XV-2 / 9	8,40	90,4	40,6	90,4	40,6	94,2	40,6	260	300	700	3500
XV-2 / 11	10,80	94,4	45	94,4	45	98,2	45	260	300	700	3500
XV-2 / 14	14,40	100,4	45	100,4	45	104,2	45	250	290	700	3500
XV-2 / 17	16,80	104,4	45	104,4	45	108,2	45	230	270	700	3500
XV-2 / 19	19,20	108,4	45	108,4	45	112,2	45	210	250	700	3000
XV-2 / 22	22,80	114,4	52,5	114,4	52,5	118,2	52,5	200	240	700	3000
XV-2 / 26	26,20	118,4	52,5	118,4	52,5	122,2	52,5	170	210	700	3000
XV-2 / 30	30,00	126,4	60,7	126,4	60,7	130,2	60,7	160	200	700	2500
XV-2 / 34	34,20	133,4	60,7	133,4	60,7	137,2	60,7	150	190	700	2500
XV-2 / 40	39,60	142,4	60,7	142,4	60,7	146,2	60,7	140	180	700	2000

MULTIPLE PUMP XV-2

Ø 50 "HY" Body-Shaped FLANGE

XV-2

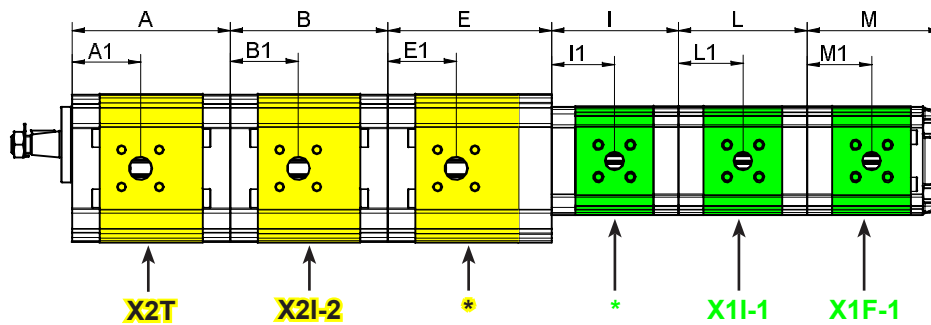
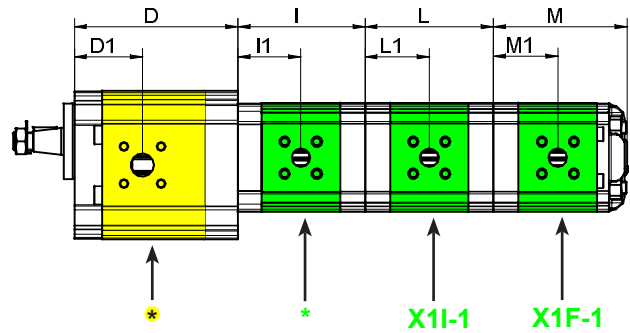
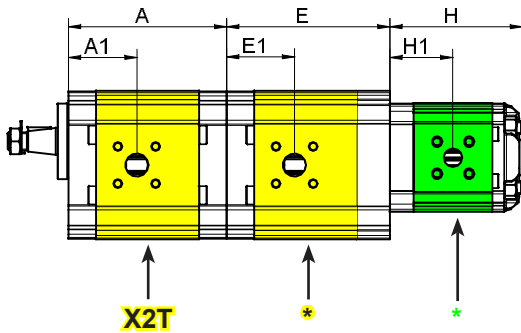
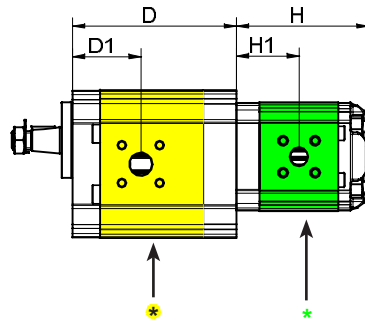
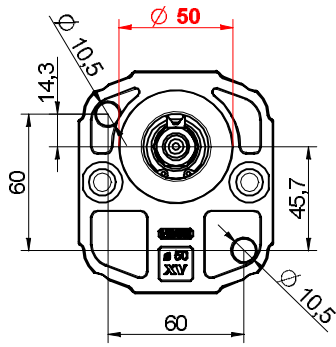

* = SPECIAL ELEMENT, please contact our customer service for details.

TYPE	Displacem cc/rev	A mm	A1 mm	B mm	B1 mm	C mm	C1 mm	D mm	D1 mm	E mm	E1 mm	F mm	F1 mm	G mm	G1 mm	P1 bar	P3 bar	Min speed rpm	Max speed rpm
XV-2 / 4	4,20	83,4	38,6	83,4	38,6	87,2	38,6	87,2	41,7	87,2	41,7	103,2	41,7	103,2	41,7	260	300	700	4000
XV-2 / 6	6,00	86,4	38,6	86,4	38,6	90,2	38,6	90,2	43,2	90,2	43,2	106,2	43,2	106,2	43,2	260	300	700	3500
XV-2 / 9	8,40	90,4	40,6	90,4	40,6	94,2	40,6	94,2	45,2	94,2	45,2	110,2	45,2	110,2	45,2	260	300	700	3500
XV-2 / 11	10,80	94,4	45	94,4	45	98,2	45	98,2	47,2	98,2	47,2	114,2	47,2	114,2	47,2	260	300	700	3500
XV-2 / 14	14,40	100,4	45	100,4	45	104,2	45	104,2	50,2	104,2	50,2	120,2	50,2	120,2	50,2	250	290	700	3500
XV-2 / 17	16,80	104,4	45	104,4	45	108,2	45	108,2	52,2	108,2	52,2	124,2	52,2	124,2	52,2	230	270	700	3500
XV-2 / 19	19,20	108,4	45	108,4	45	112,2	45	112,2	54,2	112,2	54,2	128,2	54,2	128,2	54,2	210	250	700	3000
XV-2 / 22	22,80	114,4	52,5	114,4	52,5	118,2	52,5	118,2	57,2	118,2	57,2	134,2	57,2	134,2	57,2	200	240	700	3000
XV-2 / 26	26,20	118,4	52,5	118,4	52,5	122,2	52,5	122,2	59,2	122,2	59,2	138,2	59,2	138,2	59,2	170	210	700	3000
XV-2 / 30	30,00	126,4	60,7	126,4	60,7	130,2	60,7	130,2	63,2	130,2	63,2	146,2	63,2	146,2	63,2	160	200	700	2500
XV-2 / 34	34,20	133,4	60,7	133,4	60,7	137,2	60,7	137,2	66,7	137,2	66,7	153,2	66,7	153,2	66,7	150	190	700	2500
XV-2 / 40	39,60	142,4	60,7	142,4	60,7	146,2	60,7	146,2	71,2	146,2	71,2	162,2	71,2	162,2	71,2	140	180	700	2000

MULTIPLE PUMP XV-2

ø 50 "HY" Body-Shaped FLANGE

XV-2

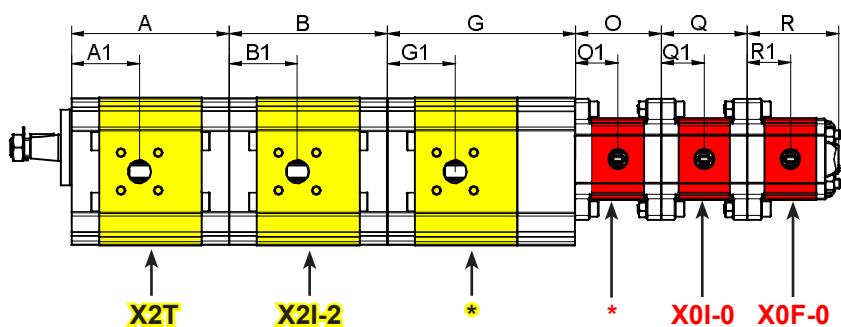
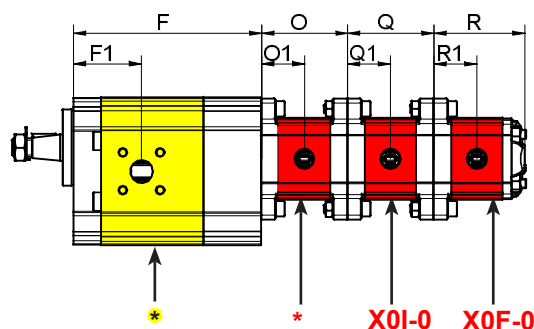
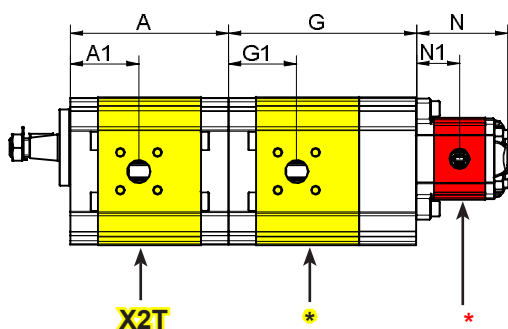
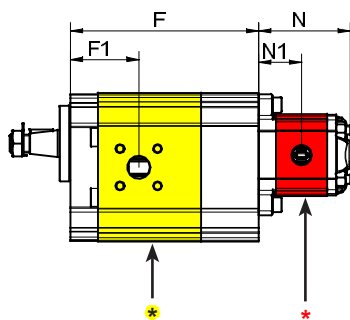

TYPE	Displacement cc/rev	H mm	H1 mm	I mm	I1 mm	L mm	L1 mm	M mm	M1 mm	P1 bar	P3 bar	Min speed rpm	Max speed rpm
XV-1 / 0,9	0,91	77	36,3	73,5	36,3	74,5	37,3	78	37,3	240	280	700	6000
XV-1 / 1,2	1,17	78	36,8	74,5	36,8	75,5	37,8	79	37,8	250	290	700	6000
XV-1 / 1,7	1,56	79,5	37,5	76	37,5	77	38,5	80,5	38,5	250	290	700	6000
XV-1 / 2,2	2,08	81,5	38,5	78	38,5	79	39,5	82,5	39,5	250	290	700	6000
XV-1 / 2,6	2,60	83,5	39,5	80	39,5	81	40,5	84,5	40,5	250	300	700	6000
XV-1 / 3,2	3,12	85,5	40,5	82	40,5	83	41,5	86	41,5	250	300	700	6000
XV-1 / 3,8	3,64	87,5	41,5	84	41,5	85	42,5	88,5	42,5	250	300	700	6000
XV-1 / 4,3	4,26	89,5	42,5	86	42,5	87	43,5	90,5	43,5	250	300	700	6000
XV-1 / 4,9	4,94	92,5	44	89	44	90	45	93,5	45	250	300	700	6000
XV-1 / 5,9	5,85	96	45,8	92,5	45,8	93,5	46,8	97	46,8	250	300	700	5000
XV-1 / 6,5	6,50	98,5	47	95	47	96	48	99,5	48	250	300	700	5000
XV-1 / 7,8	7,54	102,5	49	99	49	100	50	103,5	50	220	260	700	5000
XV-1 / 9,8	9,88	111,5	53,5	108	53,5	109	54,5	112,5	54,5	190	230	700	4000

TYPE	Displacem. cc/rev	N mm	N1 mm	O mm	O1 mm	Q mm	Q1 mm	R mm	R1 mm	P1 bar	P3 bar	Min speed rpm	Max speed rpm
XV-0 / 0,17	0,16	55,8	26,2	52,3	26,2	52,3	26,2	55,8	26,2	220	260	700	9000
XV-0 / 0,25	0,24	56,4	26,5	52,9	26,5	52,9	26,5	56,4	26,5	220	260	700	9000
XV-0 / 0,45	0,45	58	27,3	54,5	27,3	54,5	27,3	58	27,3	220	280	700	9000
XV-0 / 0,57	0,56	59	27,8	55,5	27,8	55,5	27,8	59	27,8	220	280	700	9000
XV-0 / 0,76	0,75	60,5	28,5	57	28,5	57	28,5	60,5	28,5	220	280	700	9000
XV-0 / 0,98	0,92	62	29,3	58,5	29,3	58,5	29,3	62	29,3	220	280	700	6000
XV-0 / 1,27	1,26	64,5	30,5	61	30,5	61	30,5	64,5	30,5	220	280	700	6000
XV-0 / 1,52	1,48	66,5	31,5	63	31,5	63	31,5	66,5	31,5	220	280	700	6000
XV-0 / 2,30	2,28	72,5	34,5	69	34,5	69	34,5	72,5	34,5	220	210	700	5000