

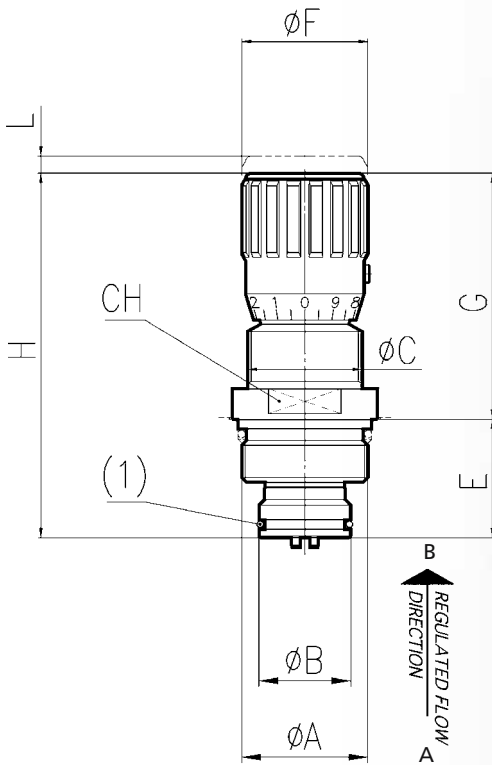

MATERIALS

BODY BASE	11S MN PB 30 - UNI EN 10087
COMPENSATION UNIT	38 NI CR MO 4 - UNI EN 10083
OR	NITRILE
ANTIEXTRUSION RING	PTFE
KNOB	GD AL SI 12 - UNI EN AB 46100

EXAMPLE FOR ORDERING

	CODE	TYPE	VITON SEAL
STEEL	FT 287/2	38	V

DIMENSIONS

TYPE	ØA UNI 4534	ØB	ØC	E	G	ØF	H	L	CH	(1) OR	WEIGHT KG
14	M33x1,5	24	M30x1,5	31	64,5	33	95,5	4,5	32	2081	0,350
38	M39x1,5	30	M35x1,5	34,5	82	38	116,5	6	38	2106	0,580
12	M48x2	35	M40x1,5	42	92,5	47	134,5	6,5	45	3118	0,960
34	M55x2	40	M50x1,5	49	115	58	164	7,5	55	3137	1,700

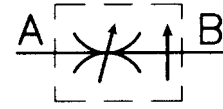

CARTRIDGE PRESSURE COMPENSATED FLOW CONTROL VALVES

Pressure compensated flow control valves, to insert in modular units in line. They are essentially composed of the central body of valves series FT 277/2 which may be screwed in units preset by the user.

The construction and functional characteristics reflect exactly those described for the two inlet valves.

It is recommended to keep them in their protective wrapping until the mounting, in order to avoid possible drawbacks caused by eventual entry of particles into the delicate and essential parts for a good working.

On page 94 is proposed a machining scheme for the embedding seat, which has to be observed to ensure the necessary accuracy of the valve.

The constructive system allows the user, already provided with those versions, either to request the two inlet base bodies only, so as to allow their quick transformation, or to store the single standard components to assemble in the various types according to the need.

On request

- Viton seals (V)



FT 287/2



TECHNICAL DATA

TYPE	MAX. WORKING PRES- SURE BAR	MIN. BURSTING PRESSU- RE BAR	WORKING TEMPERATURE °C	FILTRATION GRADE μM ABSOLUTE
14	320	7,5	-20°/+70°	25
38	320	10	-20°/+70°	25
12	320	12	-20°/+70°	25
34	320	15	-20°/+70°	25

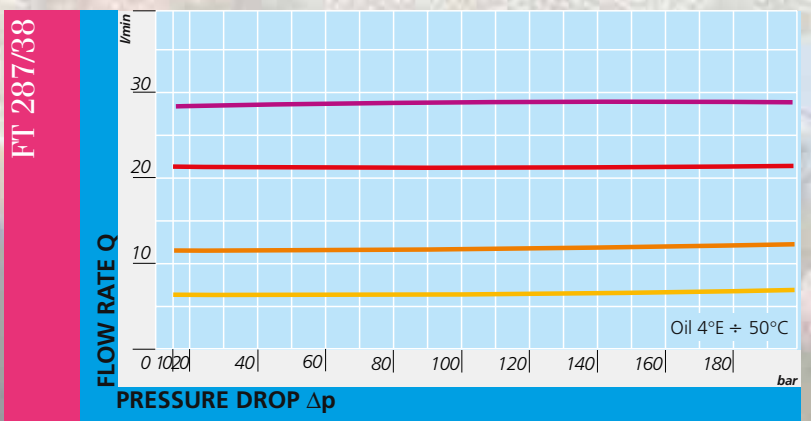
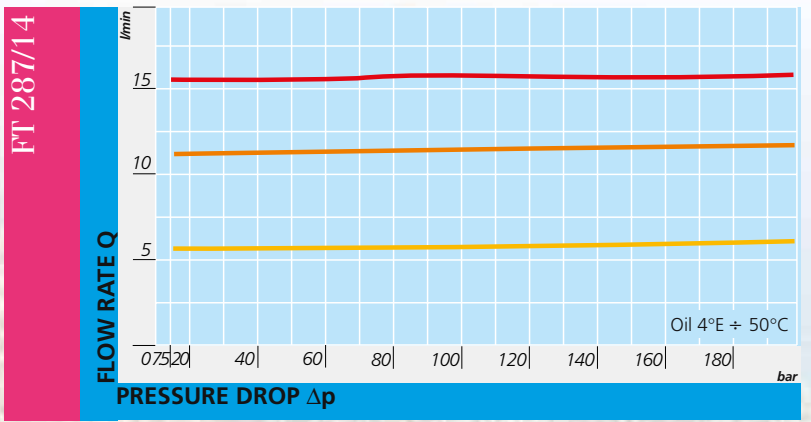
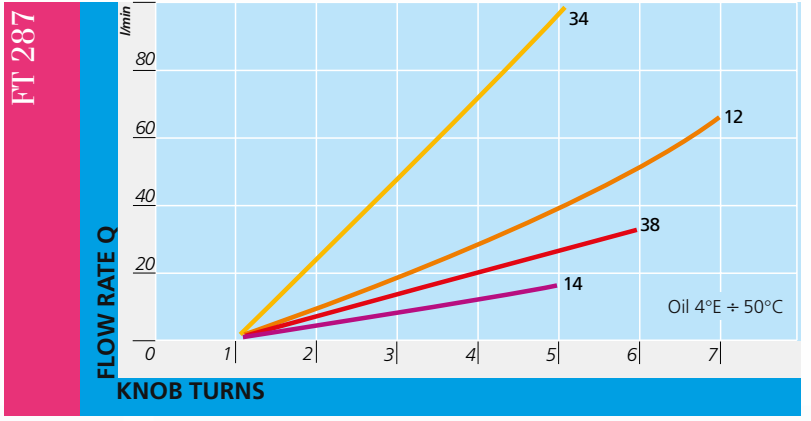

FLOW RATE CURVES



FT 287/2

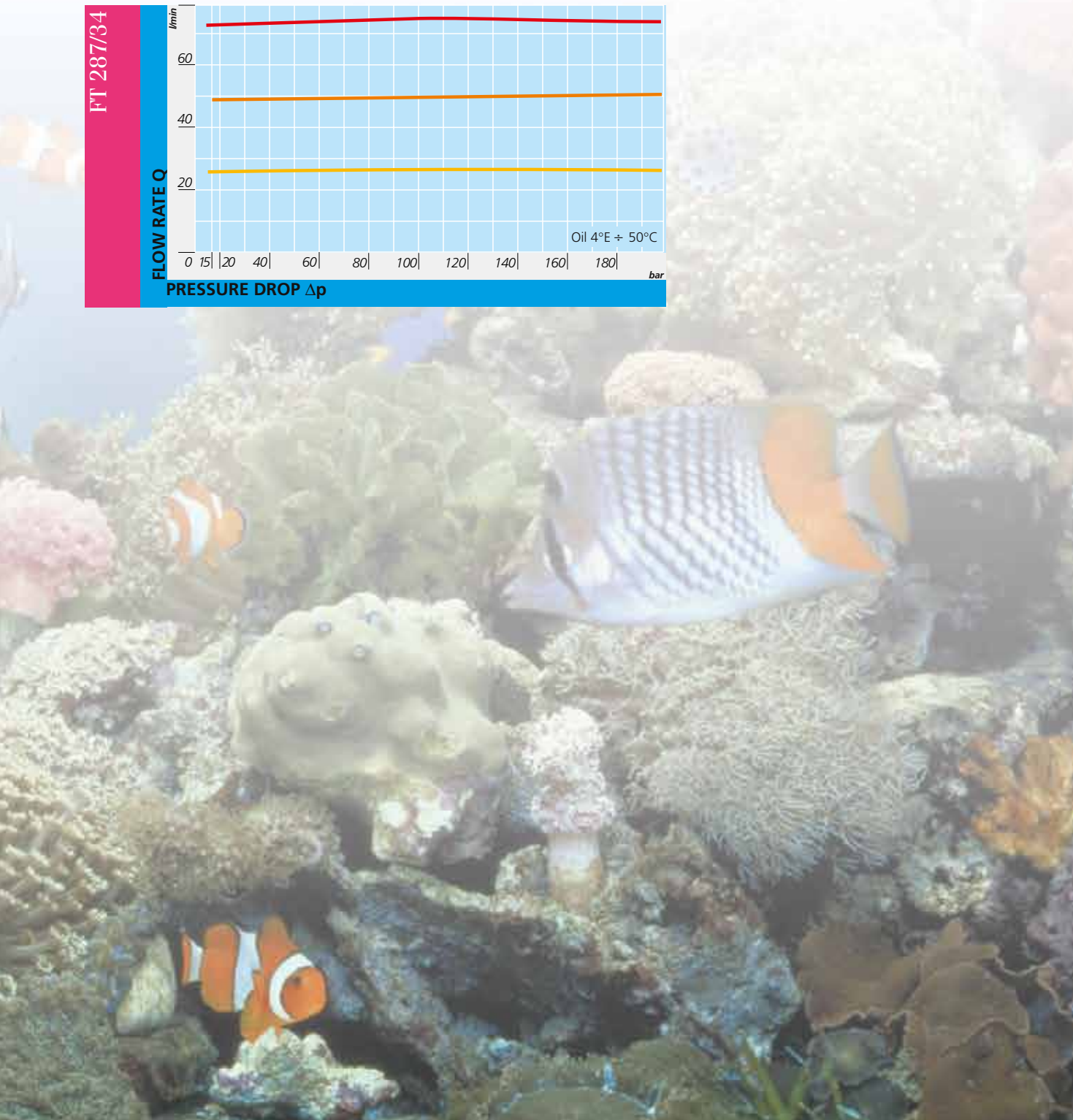
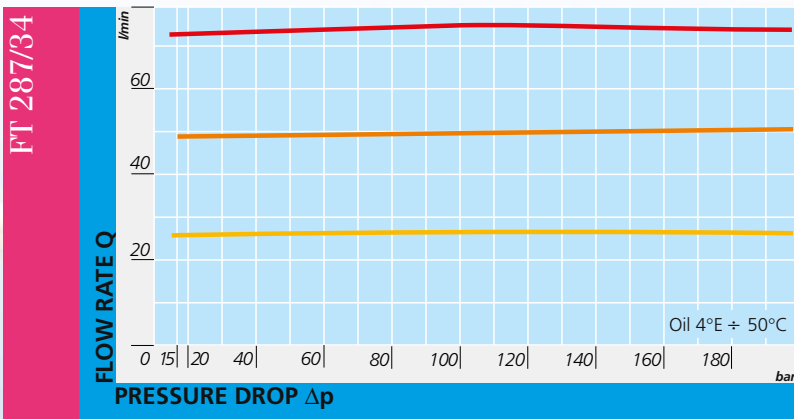
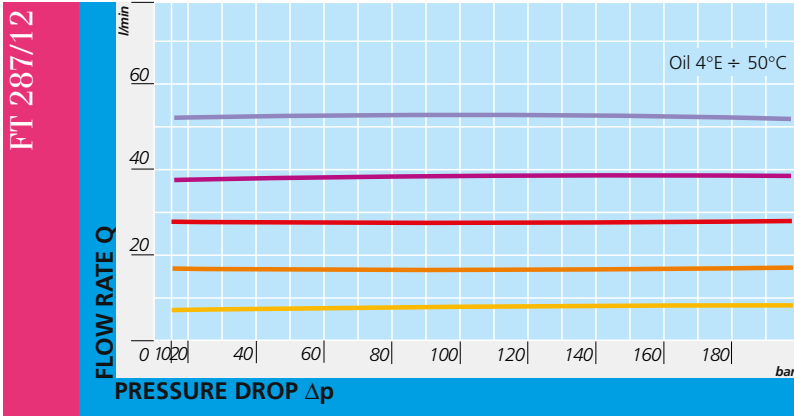

DRAWING OF CAVITY MACHINE FOR CARTRIDGE MOUNTED VALVES



FT 287/2 - FT 297/2



TYPE	ØA	ØB	C	D UNI 4535	E	F	ØG	H	ØL	M	OR	SM
14	39	35	5,2	M33x1,5	24	18	24	35,2	6,5	20	3118	0,8
38	44	40,5	5,2	M39x1,5	27,5	19	30	40	9	22,5	3143	0,8
12	53	49	6,5	M48x2	33,5	23,5	35	49	11	27,5	3175	0,8
34	63	58	7	M55x2	40	27	40	57	13,5	32,5	155	1