



BD6

BANKABLE DIRECTIONAL CONTROL VALVE SERIES 20

p max 280 bar
Q max 40 l/min

OPERATING PRINCIPLE

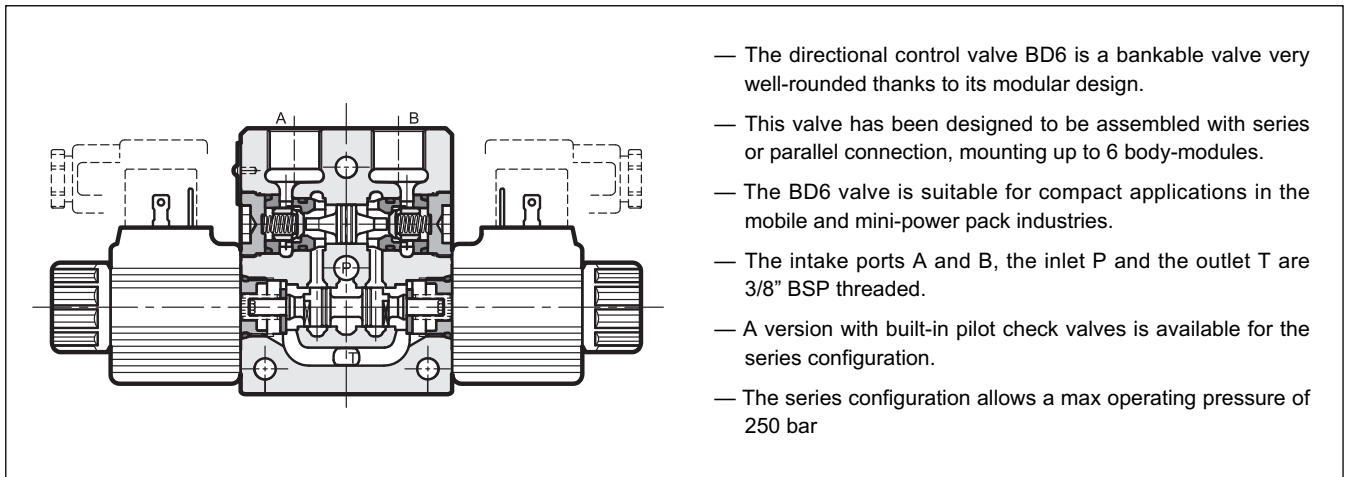

PERFORMANCES (obtained with mineral oil with viscosity of 36 cSt at 50°C)

Maximum operating pressure:		
- P-A-B ports (parallel)	bar	280
- P-A-B ports (series)		250
- T and T1 ports		250
Maximum flowrate:		
- parallel	l/min	40
- series		25
Pressure drops $\Delta p - Q$	see paragraph 3	
Electrical characteristics	see paragraph 6	
Operating limits	see paragraph 5	
Electrical connections	see paragraph 9	
Ambient temperature range	°C	-20 / +50
Fluid temperature range	°C	-20 / +80
Fluid viscosity range	cSt	10 + 400
Fluid contamination degree	According to ISO 4406:1999 class 20/18/15	
Recommended viscosity	cSt	25
Single body mass	kg	1,84
Surface treatment of body and plates:	thermochemical antioxidant	

HYDRAULIC SYMBOLS

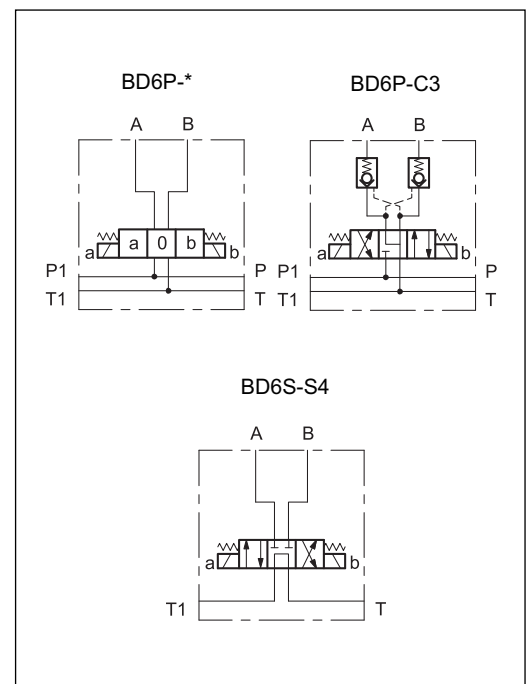

1 - IDENTIFICATION CODES FOR LOOSE MODULES

Here below all the loose components identification codes of the bankable valve are shown. To order a whole assembled valve, please use the codes at paragraphs 11 and 12.

The pressure control valve and the poppet type valve with unloading function are briefly described. For more detailed information about them please see the 21 100 datasheet for the pressure control valve and the 43 100 for the unloading valve.

1.1 - Valve body

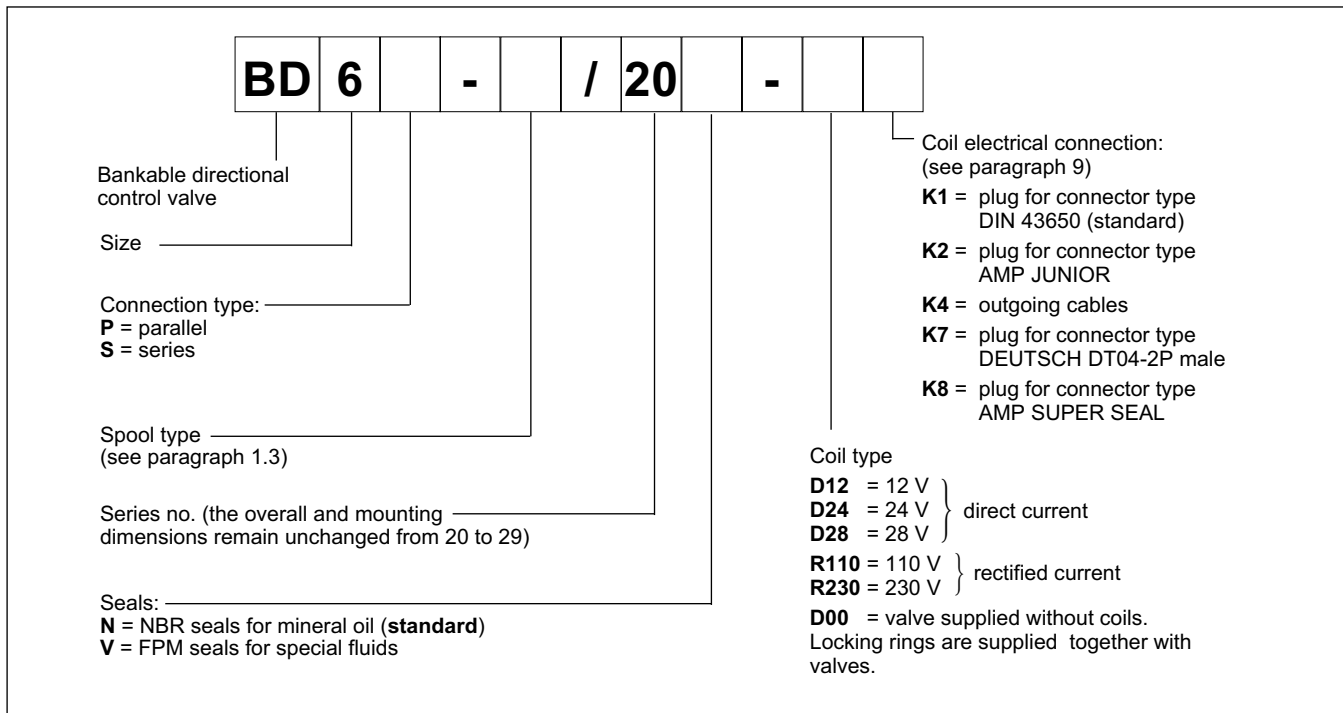

NOTE: The valve bodies and plates are supplied with a thermochemical anti-oxidation treatment.

1.2 - Coil identification code

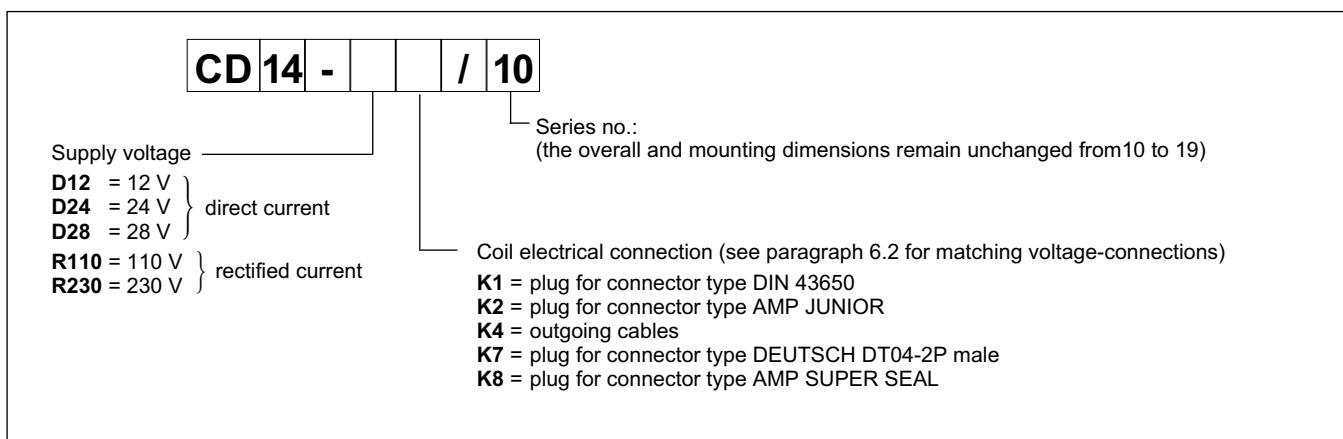

1.3 - Available spool type for parallel configuration BD6P

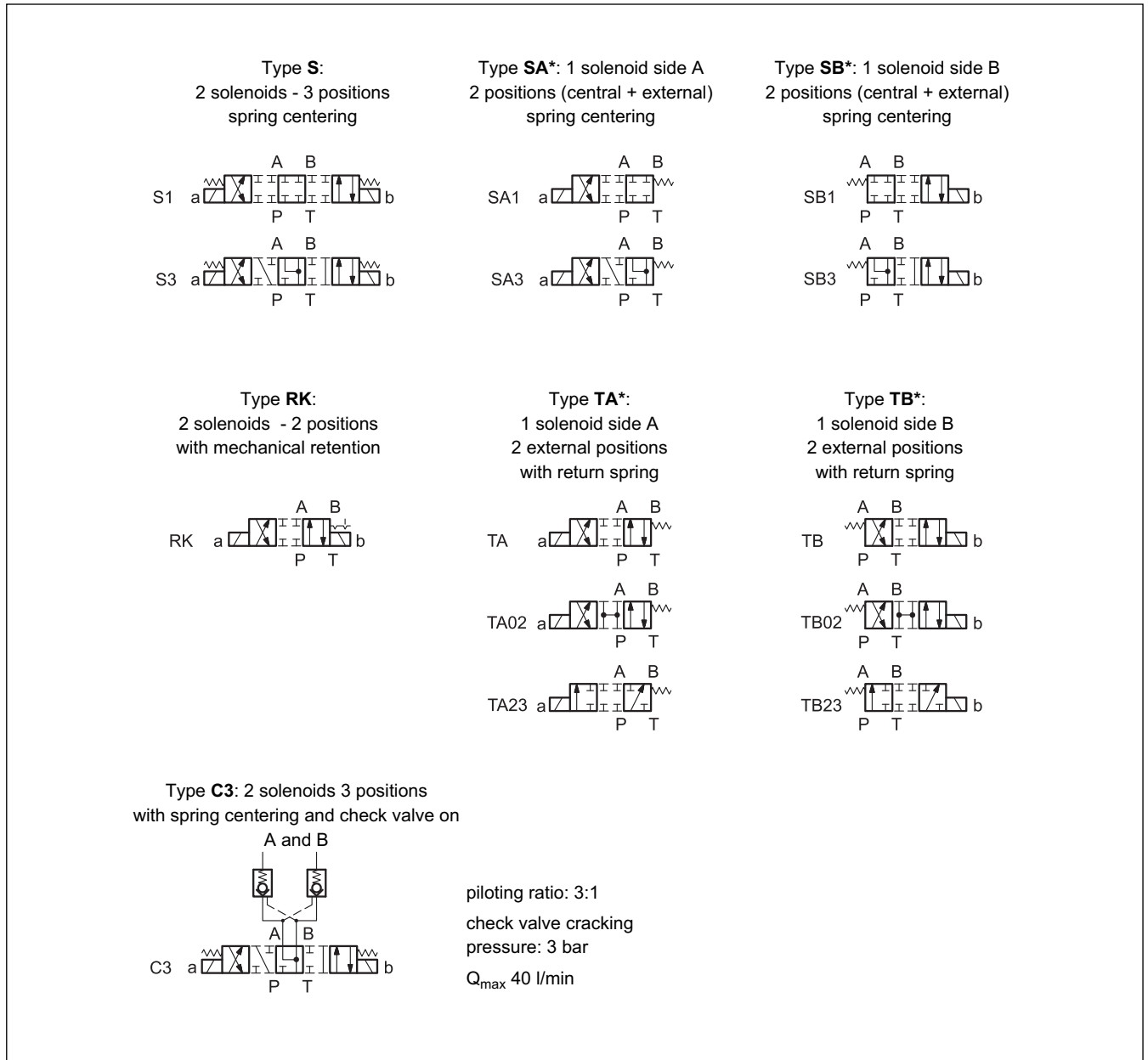

1.4 - Available spool type for series configuration BD6S

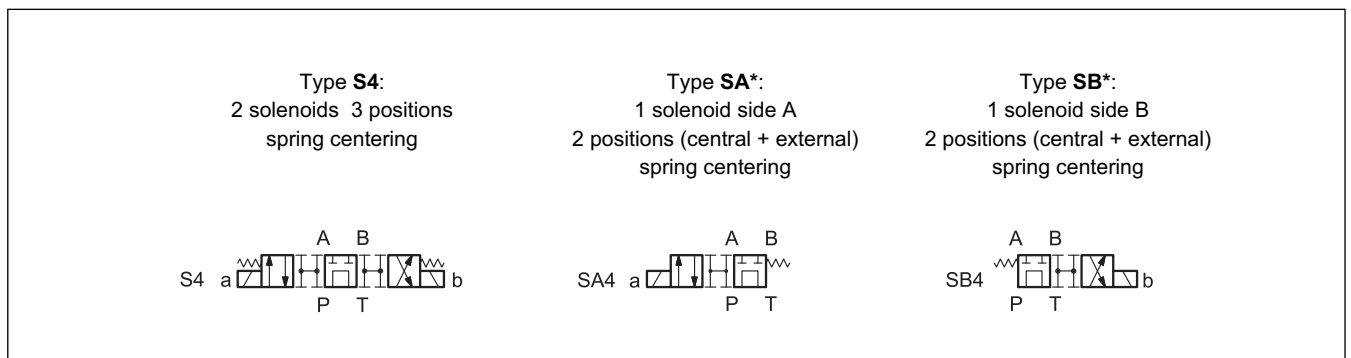

1.4 - Inlet module with pressure control valve for parallel connection

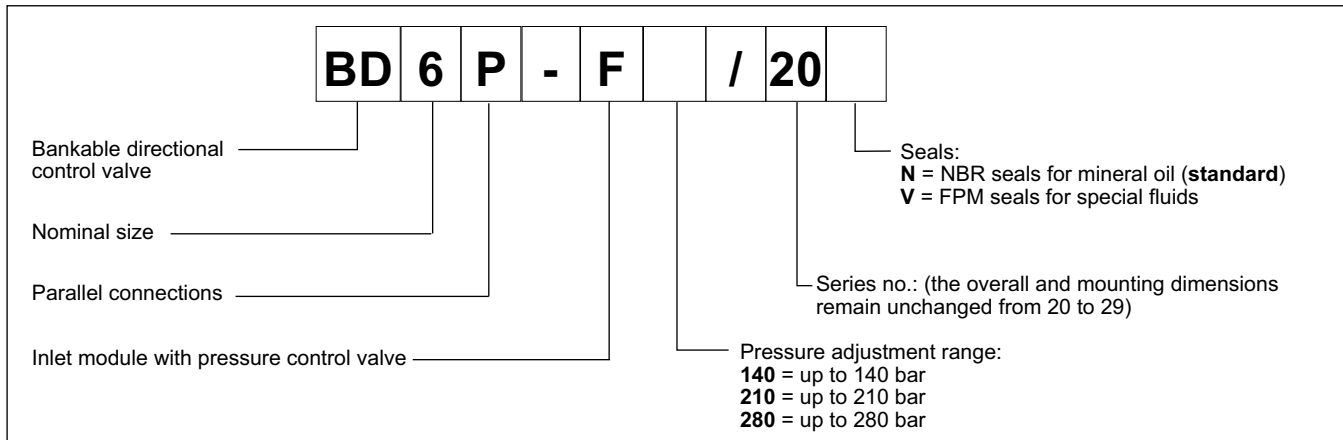

1.5 - Inlet module with pressure control valve and unloading for parallel connections

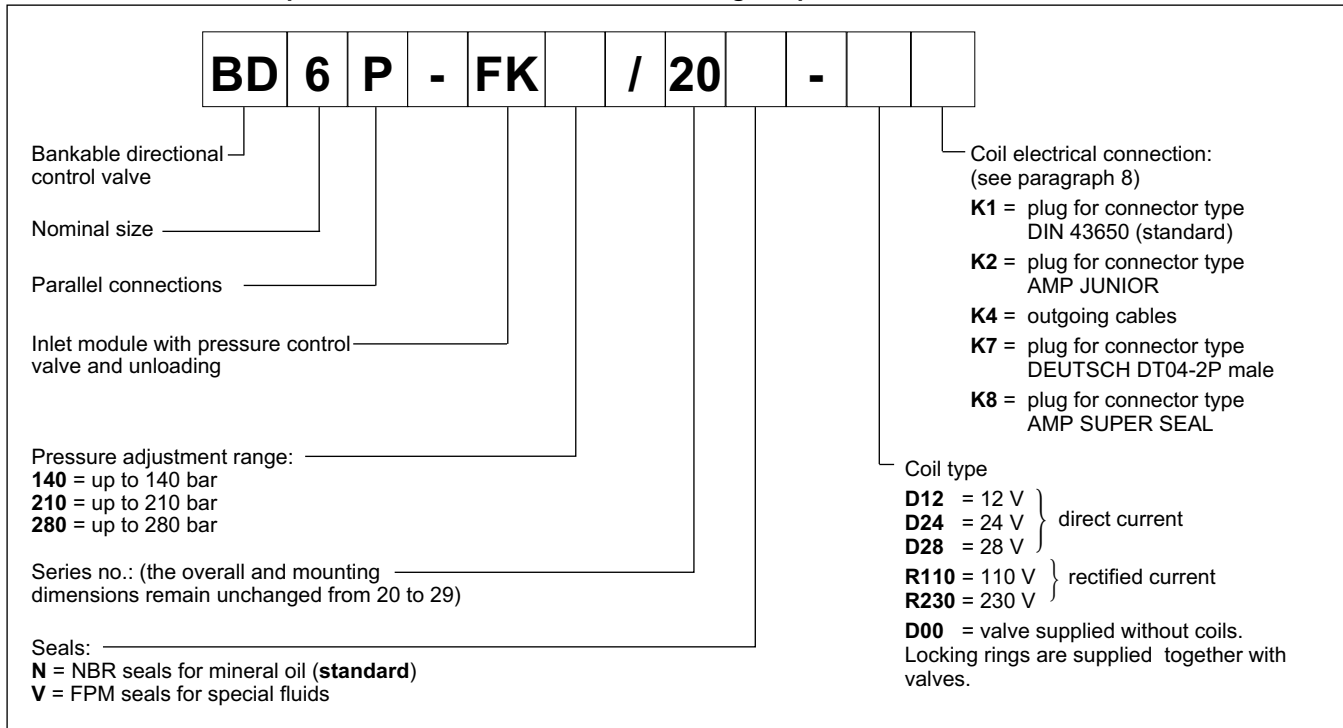

1.6 - End plate module for parallel connections

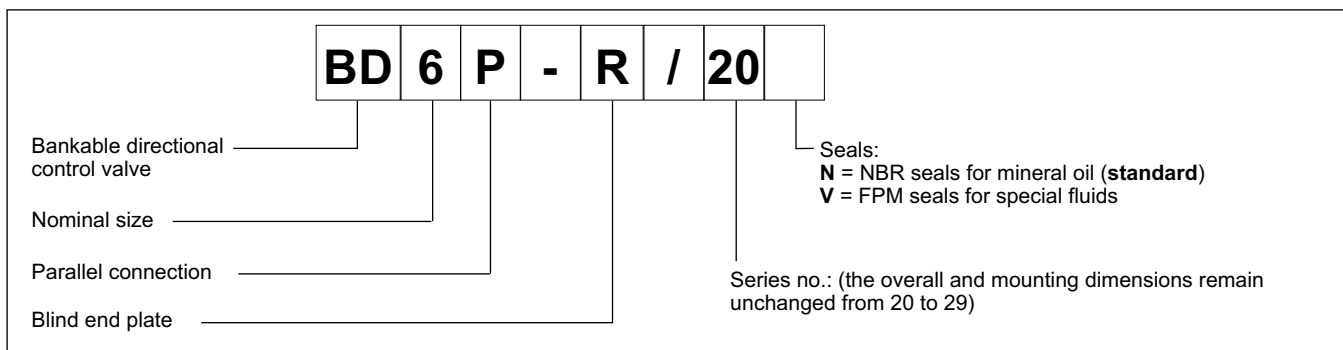

1.7 - Inlet module with pressure control valve for series connection

	BD 6 S - F / 20	
Bankable directional control valve		Seals: N = NBR seals for mineral oil (standard) V = FPM seals for special fluids
Nominal size		
Series connection		Series no.: (the overall and mounting dimensions remain unchanged from 20 to 29)
Inlet module with pressure control valve		
		Pressure adjustment range: 140 = up to 140 bar 210 = up to 210 bar (NOTE)
NOTE: Screwing completely the pressure control valve, the reachable max operating pressure is 240 bar with Q ≥ 5 l/min		

1.8 - Outlet end plate for series connection

	BD 6 S - R1 / 20	
Bankable directional control valve		Seals: N = NBR seals for mineral oil (standard) V = FPM seals for special fluids
Nominal size		
Series configuration		Series no.: (the overall and mounting dimensions remain unchanged from 20 to 29)
Outlet plate with T1 port 3/8" BSP threaded		

1.9 - Studs and fixing kit

no. of body modules	KIT code
2	3404100010
3	3404100011
4	3404100012
5	3404100013
6	3404100014

Fixing feet fastening:
n. 4 bolts M6 (not included)

The kit includes:
3 galvanized studs
6 galvanized nuts
6 galvanized safety washers
2 fixing feet

Tightening torque: 5 Nm

2 - HYDRAULIC FLUIDS

Use mineral oil-based hydraulic fluids HL or HM type, according to ISO 6743-4. For these fluids, use NBR seals (code N). For fluids HFDR type (phosphate esters) use FPM seals (code V). For the use of other kinds of fluid such as HFA, HFB, HFC, please consult our technical department. Using fluids at temperatures higher than 80 °C causes a faster degradation of the fluid and of the seals characteristics. The fluid must be preserved in its physical and chemical characteristics.

3 - CHARACTERISTIC CURVES (values obtained with viscosity 36 cSt at 50 °C)

3.1 - Body modules pressure drops Δp -Q

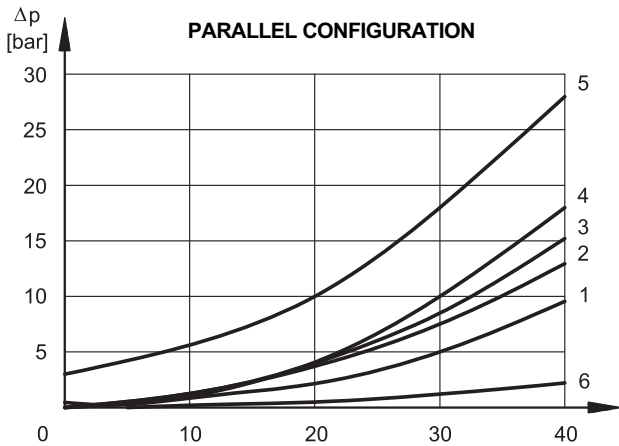

ENERGIZED VALVE

SPOOL TYPE	FLOW DIRECTION			
	P→A	P→B	A→T	B→T
	CURVES ON GRAPHS			
S1, SA1, SB1	2	2	1	1
S3, SA3, SB3	2	2	1	1
C3	5	5	3	3
TA, TB	4	4	1	1
TA02, TB02	4	4	1	1
TA23, TB23	4	4		
RK	2	2	1	1
S4, SA4, SB4	8	8	8	8

NOTE: The curve 6 shows the pressure drops in passing P or T.

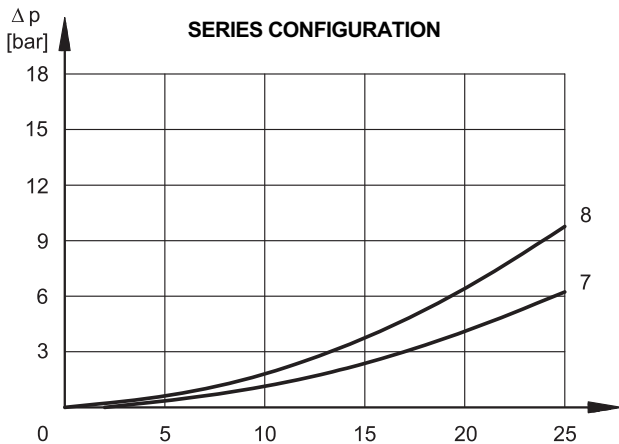

DE-ENERGIZED VALVE (central position)

SPOOL TYPE	FLOW DIRECTION				
	P→A	P→B	A→T	B→T	P→T
	CURVES ON GRAPHS				
S3, SA3, SB3			2	2	
S4, SA4, SB4					7

3.1 - Inlet modules

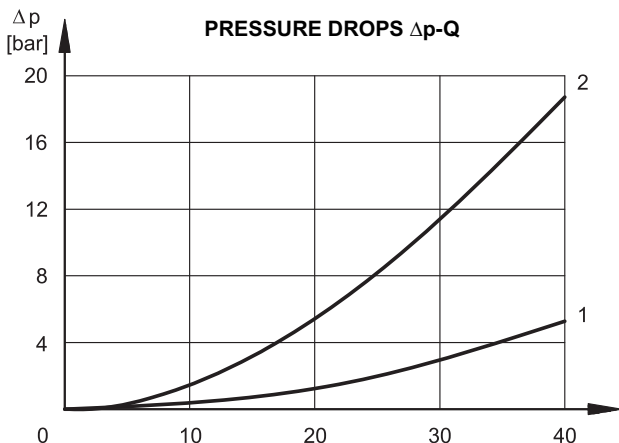

- 1 - P-T characteristic of pressure control valve wholly unscrewed
- 2 - P-T characteristic of the unloading valve

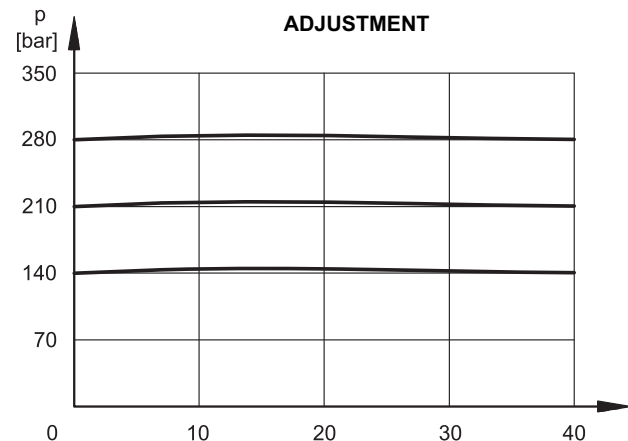

4 - SWITCHING TIMES

Values obtained according to ISO 6403, with mineral oil with viscosity 36 cSt at 50°C.

TIMES	ENERGIZING	DE-ENERGIZING
ms (±10%)	25 ÷ 75	15 ÷ 25

5 - BODY MODULE OPERATING LIMITS

The curves define the flow rate operating fields according to the valve pressure of the different versions. The values have been obtained according to ISO 6403 norm with solenoids at rated temperature and supplied with voltage equal to 90% of the nominal voltage. The value have been obtained with mineral oil, viscosity 36 cSt, temperature 50 °C and filtration according to ISO 4406:1999 class 18/16/13.

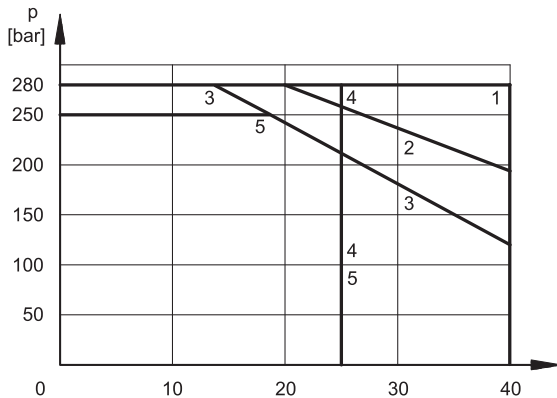

SPOOL TYPE	P-A CURVE	P-B CURVE
S1, SA1, SB1	1	1
S3, SA3, SB3	3	3
S4, SA4, SB4	5	5
TA, TB	2	2
TA02, TB02	2	2
TA23, TB23	2	2
RK	4	4
C3	3	3

6 - ELECTRICAL FEATURES

6.1 Solenoids

These are essentially made up of two parts: tube and coil. The tube is threaded into the valve body and includes the armature that moves immersed in oil, without wear. The inner part, in contact with the oil in the return line, ensures heat dissipation. The coil is fastened to the tube by a threaded ring, and can be rotated to suit the available space. The interchangeability of coils of different voltages is allowed within the same type of supply current, rectified or direct.

Protection from atmospheric agents CEI EN 60529

Connector	IP 65	IP 67	IP 69 K
K1 DIN 43650	x		
K2 AMP JUNIOR	x	x	
K4 outgoing cables	x	x	
K7 DEUTSCH DT04 male	x	x	x
K8 AMP SUPER SEAL	x	x	x

NOTE: The protection degree is guaranteed only with the connector correctly wired and installed.

SUPPLY VOLTAGE FLUCTUATION	± 10% Vnom
MAX SWITCH ON FREQUENCY	10.000 ins/hr
DUTY CYCLE	100%
ELECTROMAGNETIC COMPATIBILITY (EMC)	In compliance with 2004/108/CE
LOW VOLTAGE	In compliance with 2006/95/CE
CLASS OF PROTECTION : Coil insulation (VDE 0580) Impregnation:	class H class H

6.2 Current and absorbed power

In the table are shown current and power consumption values relevant to the different coil types. "R" coil must be used when the valve is fed with AC power supply subsequently rectified by means of rectifier bridge, externally or incorporated in the "D" type connector (see cat. 49 000).

	Resistance 20°C [Ω] (±1%)	Absorbed current [A] (±5%)	Absorbed power (±5%)		Coil code				
			[W]	[VA]	K1	K2	K4	K7	K8
CD14-D12*	5,4	2,2	26,5		1902740	1902750	1902770	1902980	1903020
CD14-D24*	20,7	1,16	27,8		1902741	1902751	1902771	1902981	1903021
CD14-D28*	27,5	1,02	28,5		1902744				
CD14-R110*	363	0,25		27,2	1902742				
CD14-R230*	1640	0,11		26,4	1902743				

7 - OVERALL AND MOUNTING DIMENSIONS

7.1 - Body module

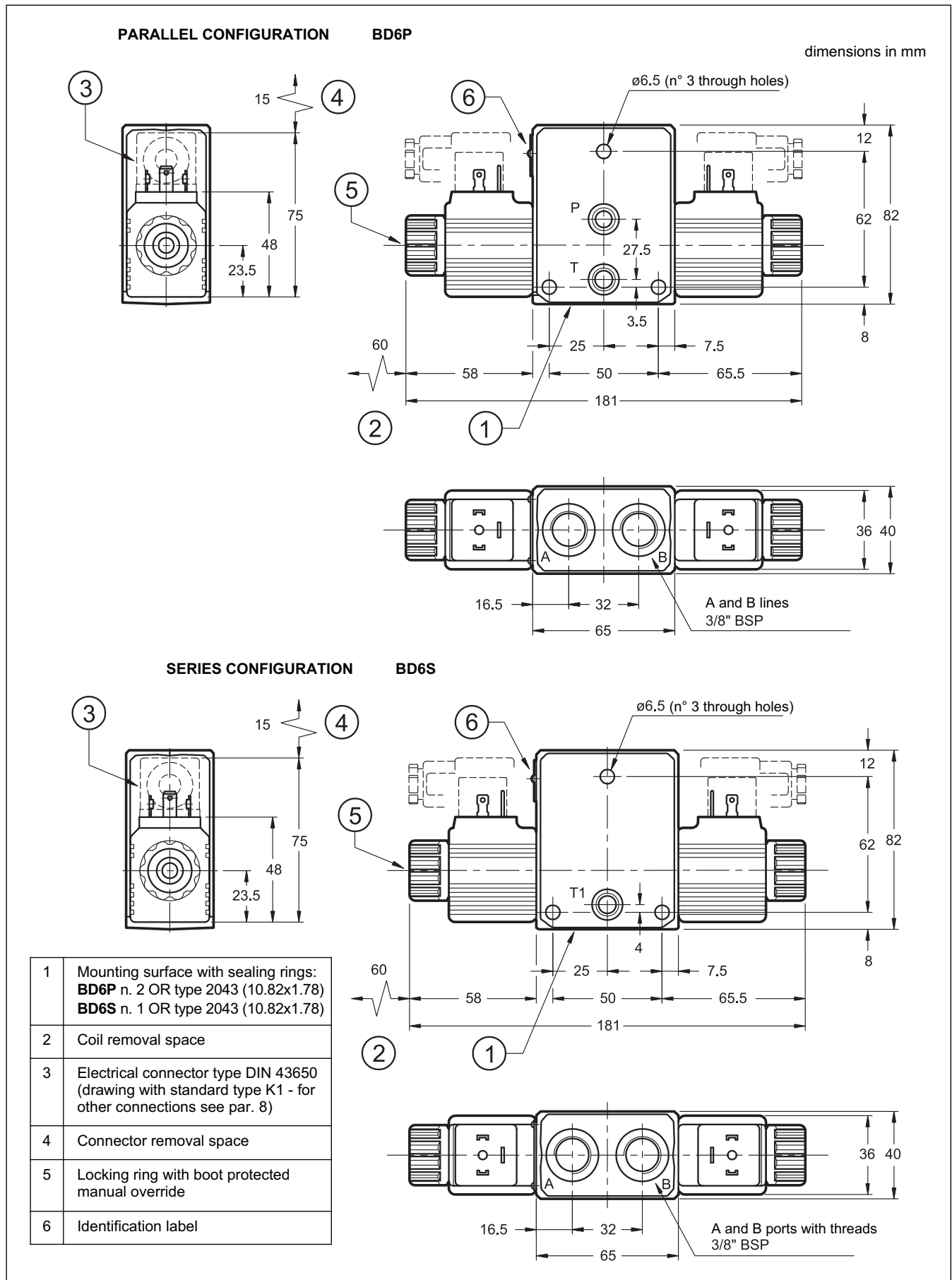

7.2 - Inlet modules for parallel configuration

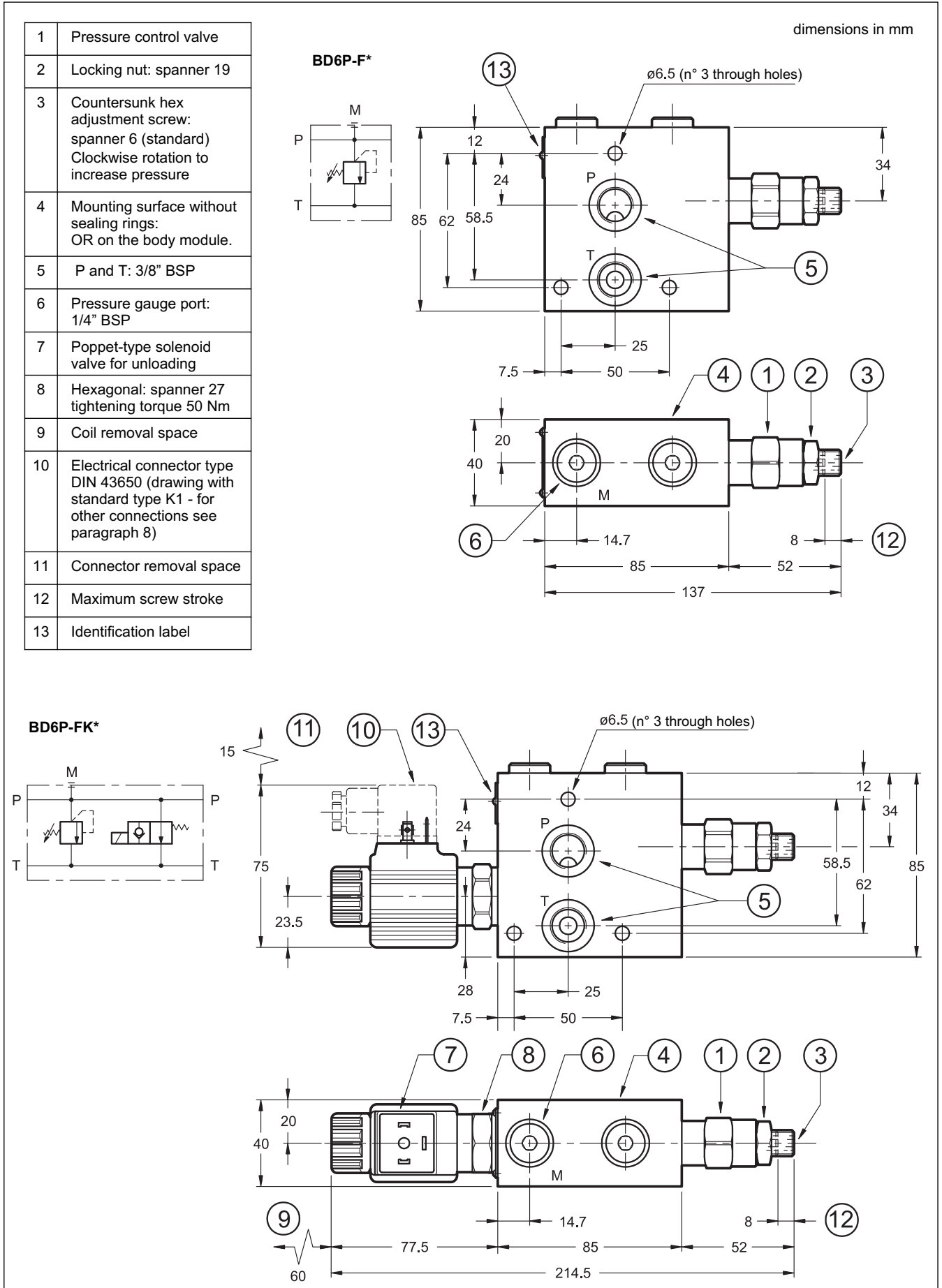

7.3 - Inlet module BD6S-F* for series configuration

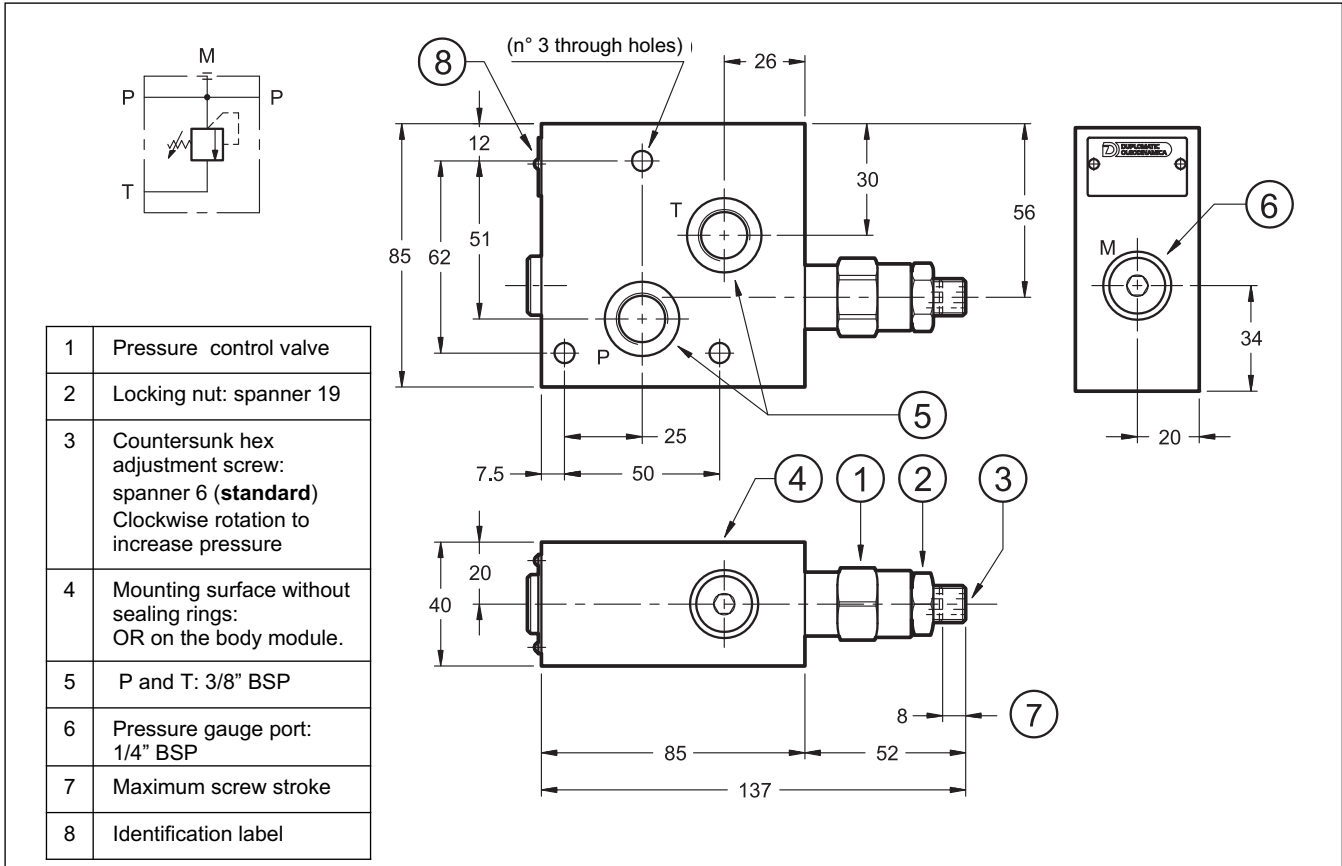

7.4 - End modules

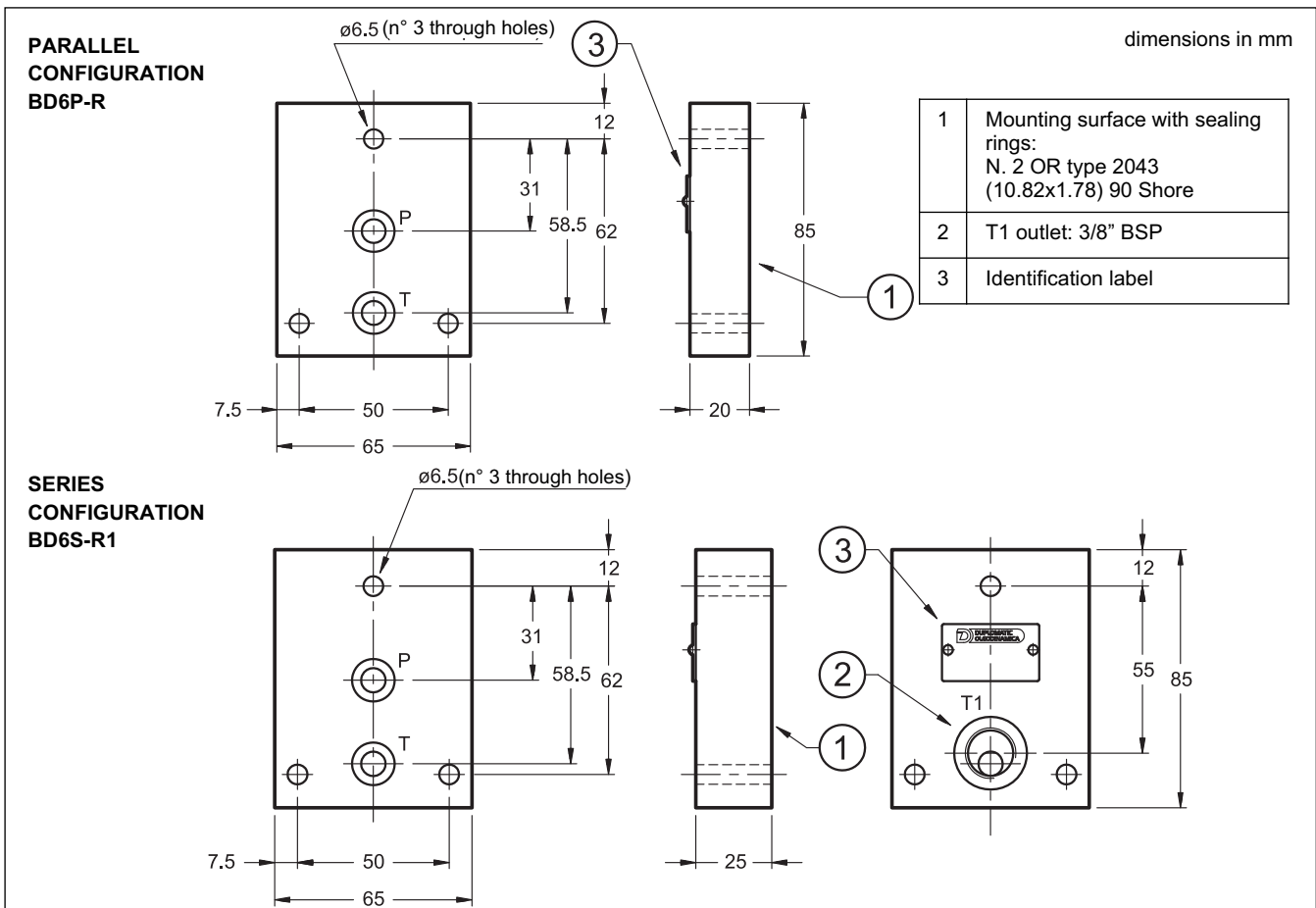

8 - INSTALLATION

Configurations with centering and return springs can be mounted in any position.

9 - ELECTRIC CONNECTIONS

connection for DIN 43650 connector code **K1**

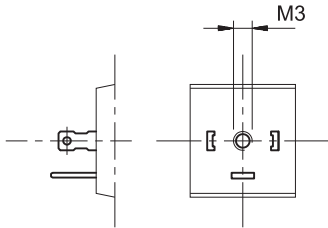

connection for AMP JUNIOR connector type code **K2**

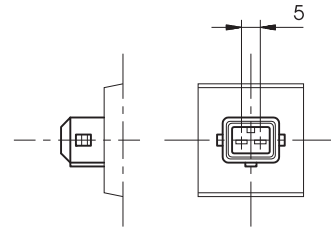

outgoing cable connections code **K4**

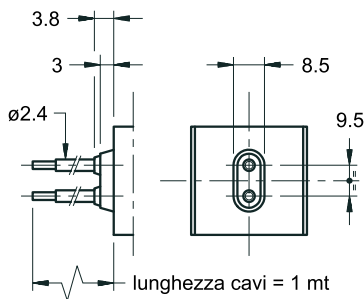

connection for DEUTSCH DT04-2P male connector type code **K7**

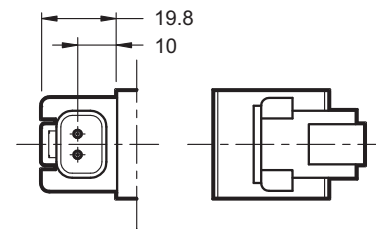

connection for AMP SUPER SEAL (two contacts) connector type code **K8**

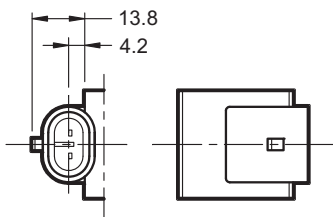

10 - ELECTRIC CONNECTORS

The solenoid valves are supplied without connectors. For coils with standard electrical connections K1 type (DIN 43650) the connectors can be ordered separately. For the identification of the connector type to be ordered please see cat. 49 000.

For K2, K7 and K8 connection type the relative connectors are not available.

11 - ASSEMBLED VALVE - PARALLEL CONFIGURATION

11.1 - Identification code

BD6	-	P	-	/	/	R	/	20	-	-
-----	---	---	---	---	---	---	---	----	---	---

Bankable directional control valve

Parallel configuration

No. of body modules

Inlet module
F = with pressure control valve
FK = with pressure control valve and unloading valve

Pressure adjustment range:
140 = up to 140 bar
210 = up to 210 bar
280 = up to 280 bar

Spool type:
Enter the spool type.
See the available spools at paragraph 1.3
Repeat for each module.

Blind end plate

Series no.: (the overall and mounting dimensions remain unchanged from 20 to 29)

Coil electrical connection: (see paragraph 9)

K1 = plug for connector type DIN 43650 (standard)

K2 = plug for connector type AMP JUNIOR

K4 = outgoing cables

K7 = plug for connector type DEUTSCH DT04-2P male

K8 = plug for connector type AMP SUPER SEAL

Coil type

D12 = 12 V } direct current
D24 = 24 V } (standard)

R110 = 110 V } rectified current
R230 = 230 V }

D00 = Valve supplied without coils (see par. 1.1 for available coils). Locking rings are supplied together with valves.

Seals:
N = NBR seals for mineral oil (standard)
V = FPM seals for special fluids

Coding example:

BD6-P4-F140/S1-S1-S1-S1/R/20N-D24K1: assembled valve includes: inlet module with pressure control valve with adjustment up to 140 bar; 4 body modules S1; blind end plate; NBR seals, 24V DC coils and K1 connection.

BD6-P3-FK280/S1-C3-S1/R/20N-D24K1: assembled valve includes: inlet module with pressure control valve with adjustment up to 280 bar and unloading valve; 1st body module with spool S1, 2nd body module with spool C3 and 3th body module with spool S1; blind end plate; NBR seals, 24V DC coils and K1 connection.

11.2 - Hydraulic symbols and connection scheme

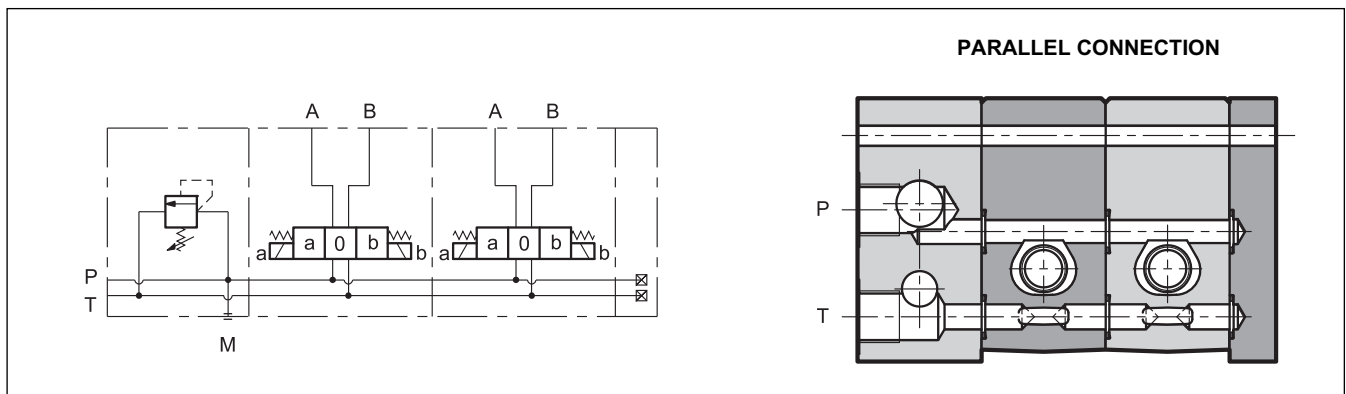

12 - ASSEMBLED VALVE - SERIES CONFIGURATION

12.1 - Identification code

BD6	-	S	-	F	/		/	R1	/	20	-		
------------	----------	----------	----------	----------	----------	--	----------	-----------	----------	-----------	----------	--	--

Bankable directional control valve

Series configuration

No. of body modules

Inlet module with pressure relief control valve

Pressure adjustment range:
140 = up to 140 bar
210 = up to 210 bar (**NOTE**)

Spool type:
 Enter the spool type.
 See the available spools at paragraph 1.4
 Repeat for each module.

Outlet plate with T1 port 3/8" BSP threaded

Series no.: (the overall and mounting dimensions remain unchanged from 20 to 29)

Coil electrical connection:
(see paragraph 9)

K1 = plug for connector type DIN 43650

K2 = plug for connector type AMP JUNIOR

K4 = outgoing cables

K7 = plug for connector type DEUTSCH DT04-2P male

K8 = plug for connector type AMP SUPER SEAL

Coil type

D12 = 12 V } direct current
D24 = 24 V }
D28 = 28 V }

R110 = 110 V } rectified current
R230 = 230 V }

D00 = valve supplied without coils. Locking rings are supplied together with valves.

Seals:
N = NBR seals for mineral oil (**standard**)
V = FPM seals for special fluids

NOTE: Screwing completely the pressure control valve, the reachable max operating pressure is 240 bar with Q ≥ 5 l/min

Coding example:
BD6-S3-F140/S4-SB4-SA4/R1/20N-D24K1: assembled valve includes: inlet module with pressure control relief valve, with adjustment up to 140 bar, 1st body module with spool S4, 2nd body module with spool SB4 and 3th body module with spool SA4; outlet plate; NBR seals, 24V DC coils and K1 connection.

12.2 - Hydraulic symbols and connection scheme

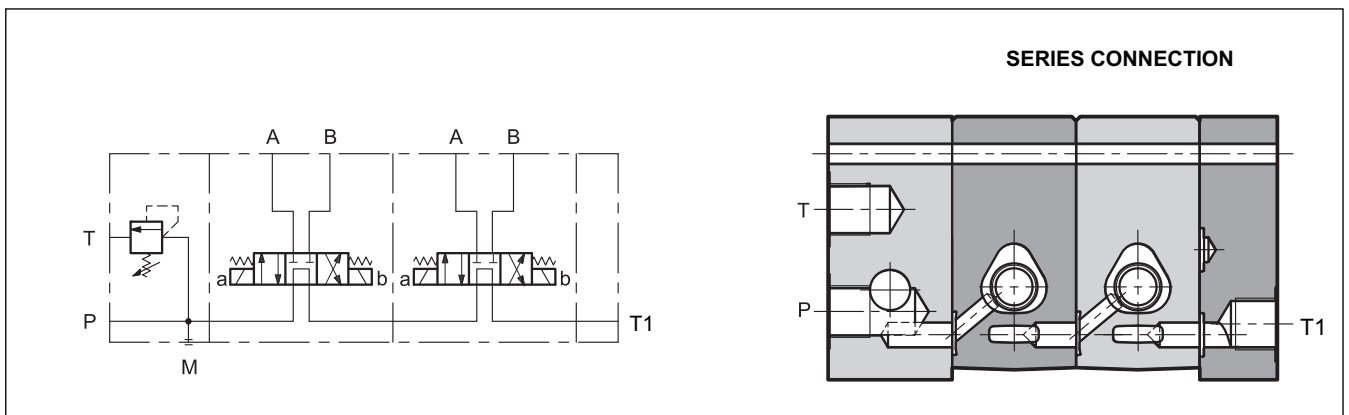

13 - OVERALL DIMENSION OF THE ASSEMBLED VALVE IN PARALLEL CONFIGURATION

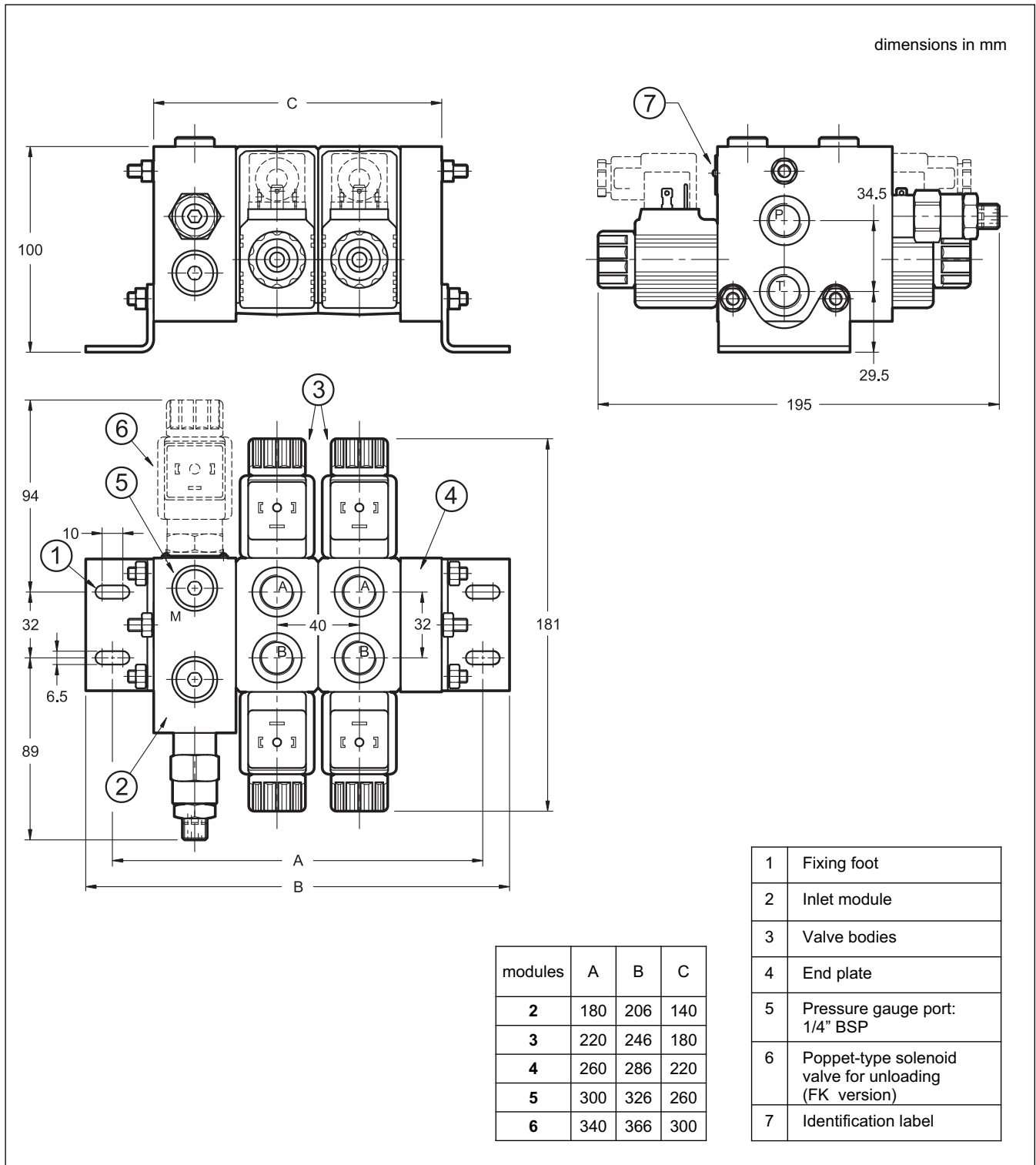

14 - OVERALL DIMENSION OF THE ASSEMBLED VALVE IN SERIES CONFIGURATION

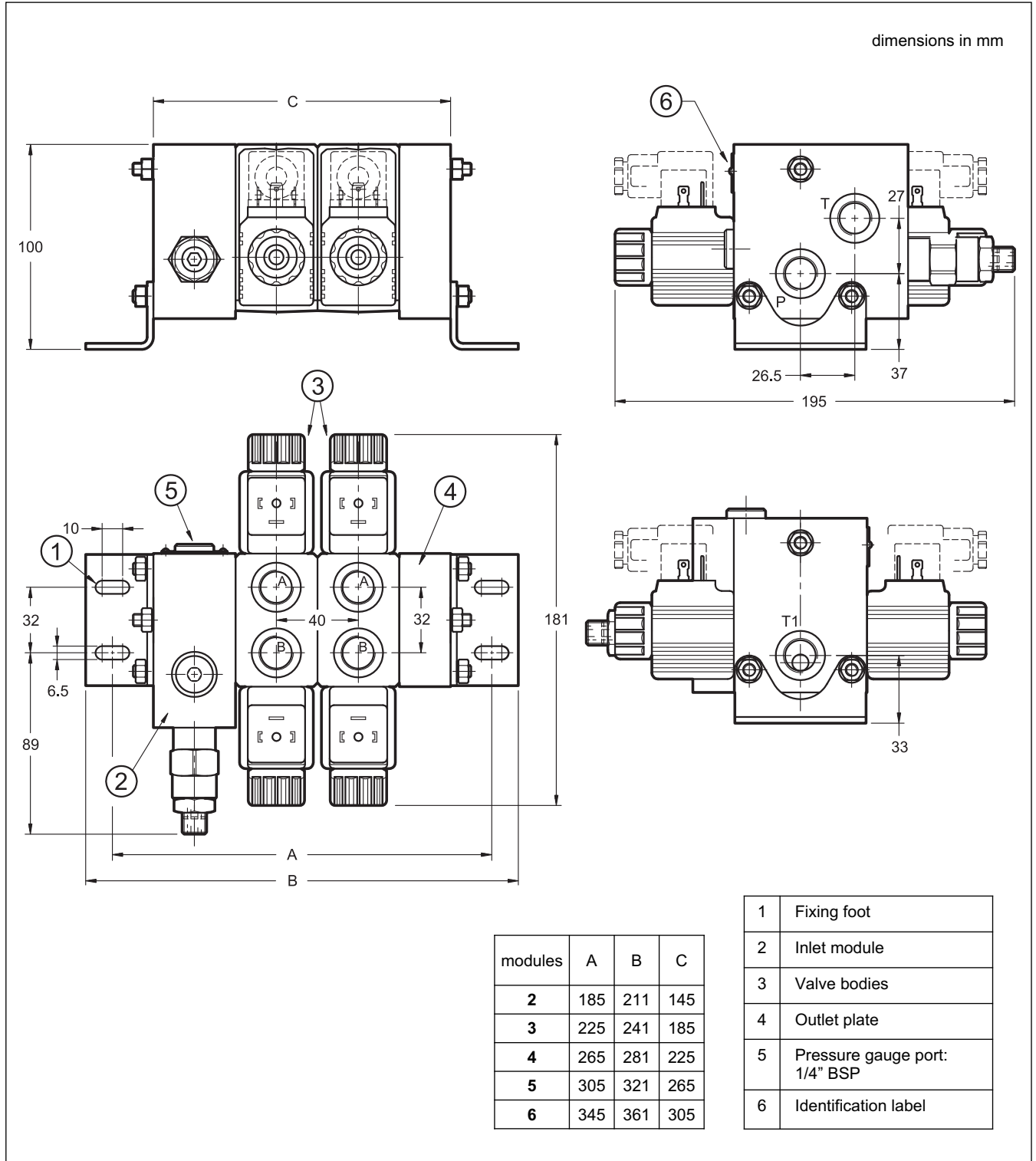



BD6
SERIES 20



DIPLOMATIC OLEODINAMICA S.p.A.
20015 PARABIAGO (MI) • Via M. Re Depaolini 24
Tel. +39 0331.895.111
Fax +39 0331.895.339
www.diplomatic.com • e-mail: sales.exp@diplomatic.com

