

intermediate pump - series XV

XO1-0

SHAPED INTERMEDIATE PUMP
SHAPED FEMALE Ø22 FLANGE

X 0 I 06 24 M B B D

Series	X	series XV
Group	0	group 0
Category	I	intermediate pump
Displacement	06	0.76
Flange	24	Ø22 body-shaped female right rotation 0P+0P
Shaft	M	CFI01 - Intermediate - (Milled shank ø7 - thk.3)
Body	IN	inlet - 1/4" GAS
	OUT	outlet - 1/4" GAS
Cover	D	Ø22 female cover for left multiple pump element

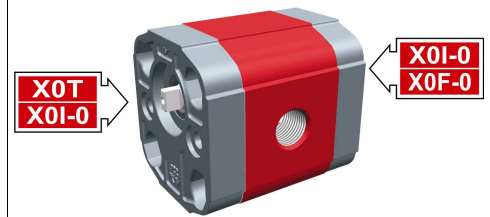

XI002

Technical data table

TYPE	Displacement cm3/rev	Max. Pressure		CODE	
		P1 bar	P3 bar	Left rotation	Right rotation
XO1-0/0.17	0,16	220	260	X 0 I 01 23 M B B A	X 0 I 01 24 M B B A
XO1-0/0.25	0,24	220	260	X 0 I 02 23 M B B A	X 0 I 02 24 M B B A
XO1-0/0.45	0,45	220	280	X 0 I 04 23 M B B A	X 0 I 04 24 M B B A
XO1-0/0.57	0,56	220	280	X 0 I 05 23 M B B A	X 0 I 05 24 M B B A
XO1-0/0.76	0,75	220	280	X 0 I 06 23 M B B A	X 0 I 06 24 M B B A
XO1-0/0.98	0,92	220	280	X 0 I 07 23 M B B A	X 0 I 07 24 M B B A
XO1-0/1.27	1,26	220	280	X 0 I 09 23 M B B A	X 0 I 09 24 M B B A
XO1-0/1.52	1,48	220	280	X 0 I 11 23 M B B A	X 0 I 11 24 M B B A
XO1-0/2.30	2,28	190	210	X 0 I 13 23 M B B A	X 0 I 13 24 M B B A

P1) Max. working pressure - P3) Max. peak pressure

For heavy-duty applications, it is recommended to check the admissible torque of the shaft

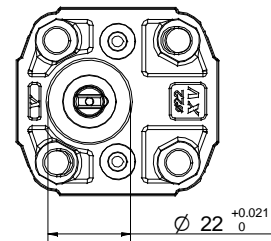

T.2

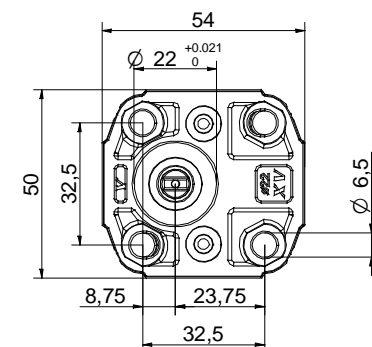
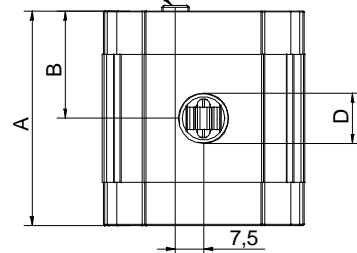

01/04/08 X010624M6B0.dft

Dimensions table







TYPE	Weight kg	A	B	D	D
		mm	mm	IN	OUT
XO1-0/0.17	0,400	52,3	26,2	1/4" BSPP	1/4" BSPP
XO1-0/0.25	0,410	52,9	26,5	1/4" BSPP	1/4" BSPP
XO1-0/0.45	0,420	54,5	27,3	1/4" BSPP	1/4" BSPP
XO1-0/0.57	0,430	55,5	27,8	1/4" BSPP	1/4" BSPP
XO1-0/0.76	0,440	57,0	28,5	1/4" BSPP	1/4" BSPP
XO1-0/0.98	0,460	58,5	29,3	1/4" BSPP	1/4" BSPP
XO1-0/1.27	0,480	61,0	30,5	1/4" BSPP	1/4" BSPP
XO1-0/1.52	0,500	63,0	31,5	1/4" BSPP	1/4" BSPP
XO1-0/2.30	0,560	69,0	34,5	1/4" BSPP	1/4" BSPP

T.2 = 3.7 [Nm] - admissible shaft torque (N.B. When choosing a shaft, always check the admissible torque).

Table of variations

XOI-O

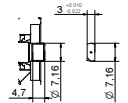
Shaped female $\varnothing 22$ FLANGE

Shaped female $\varnothing 22$ FLANGE				Shaft		Cover		
Left rotation		Right rotation				Left rotation	Right rotation	
	23		24	CFI01 - Milled shank T.2 = 3.7 [Nm]				A
				 M				

Displacement	
TYPE	CODE
XOI-0/0.17	01
XOI-0/0.25	02
XOI-0/0.45	04
XOI-0/0.57	05
XOI-0/0.76	06
XOI-0/0.98	07
XOI-0/1.27	09
XOI-0/1.52	11
XOI-0/2.30	13

Standard bodies	
Displacement cm ³ /rev	standard thread
0.17	B - B
0.25	B - B
0.45	B - B
0.57	B - B
0.76	B - B
0.98	B - B
1.27	B - B
1.52	B - B
2.30	B - B

Table showing standard flange and thread combinations available in stock

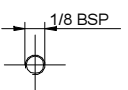
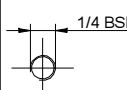
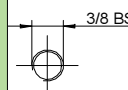
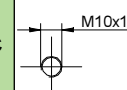
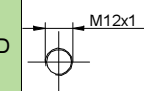
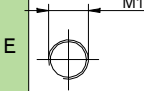
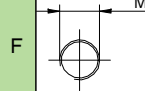
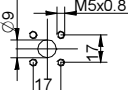
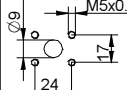
Body (threads/flanges)													
	A		B		C		D		E		F		G
	H		I	Closed Body		Z							