

reversible pump - series XV

XV-OR

BH TYPE PUMP

ø22 BODY-SHAPED FLANGE - MILLED SHANK

X 0 R 06 07 B B B E

Series	X	series XV
Group	0	group 0
Category	R	reversible pump
Displacement	06	0.76
Flange	07	ø22 BH reversible rotation
Shaft	B	CF001 - Milled shank ø7 - thk.5
Body	IN	inlet - 1/4" GAS
	OUT	outlet - 1/4" GAS
Cover	E	reversible w/external drainage



XR012

Technical data table						
TYPE	Displacement cm3/rev	Max. Pressure		CODE		
		P1 bar	P3 bar	External drainage		Internal drainage
XV-OR/0.17	0,16	220	260	X 0 R 01 07 B B B E	X 0 R 01 07 B B B F	
XV-OR/0.25	0,24	220	260	X 0 R 02 07 B B B E	X 0 R 02 07 B B B F	
XV-OR/0.45	0,45	220	280	X 0 R 04 07 B B B E	X 0 R 04 07 B B B F	
XV-OR/0.57	0,56	220	280	X 0 R 05 07 B B B E	X 0 R 05 07 B B B F	
XV-OR/0.76	0,75	220	280	X 0 R 06 07 B B B E	X 0 R 06 07 B B B F	
XV-OR/0.98	0,92	220	280	X 0 R 07 07 B B B E	X 0 R 07 07 B B B F	
XV-OR/1.27	1,26	220	280	X 0 R 09 07 B B B E	X 0 R 09 07 B B B F	
XV-OR/1.52	1,48	220	280	X 0 R 11 07 B B B E	X 0 R 11 07 B B B F	
XV-OR/2.30	2,28	190	210	X 0 R 13 07 B B B E	X 0 R 13 07 B B B F	

P1) Max. working pressure - P3) Max. peak pressure

For heavy-duty applications, it is recommended to check the admissible torque of the shaft

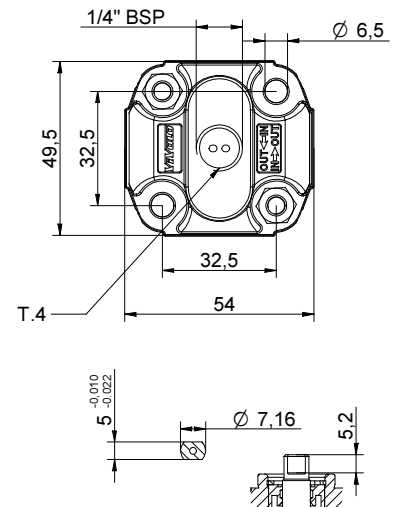

Dimensions table						
TYPE	Weight kg	A	B	C	D	D
		mm	mm	mm	IN	OUT
XV-OR/0.17	0,400	55,8	26,2	46,8	1/4" BSPP	1/4" BSPP
XV-OR/0.25	0,410	56,4	26,5	47,4	1/4" BSPP	1/4" BSPP
XV-OR/0.45	0,420	58,0	27,3	49,0	1/4" BSPP	1/4" BSPP
XV-OR/0.57	0,430	59,0	27,8	50,0	1/4" BSPP	1/4" BSPP
XV-OR/0.76	0,440	60,5	28,5	51,5	1/4" BSPP	1/4" BSPP
XV-OR/0.98	0,460	62,0	29,3	53,0	1/4" BSPP	1/4" BSPP
XV-OR/1.27	0,480	64,5	30,5	55,5	1/4" BSPP	1/4" BSPP
XV-OR/1.52	0,500	66,5	31,5	57,5	1/4" BSPP	1/4" BSPP
XV-OR/2.30	0,560	72,5	34,5	63,5	1/4" BSPP	1/4" BSPP

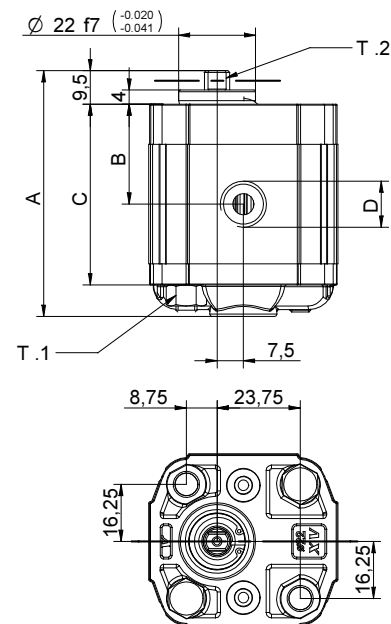

26/08/04 XR0607888E.dft

T.1 = 11.7÷13.7 [Nm] - screw tightening torque M6



T.2 = 9.2 [Nm] - admissible shaft torque (N.B. When choosing a shaft, always check the admissible torque).

T.4 = 0.3÷0.5 bar - max. drainage pressure

Table of variations

XV-OR

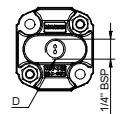
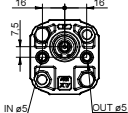
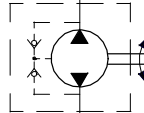
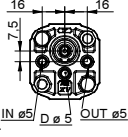
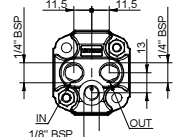
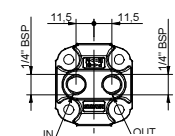
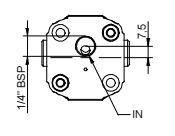
ø22 "BH" Body-Shaped FLANGE

ø22 "BH" Body-Shaped FLANGE		Shaft		Cover			
	07	CI001 - Parallel T.2 = 2.1 [Nm]	A	CF001 - Milled shank T.2 = 9.2 [Nm]	B	 External drainage	E
	10	CF005 - Milled shank T.2 = 8.4 [Nm]	F	CO001 - Tapered T.2 = 21.9 [Nm]	E	 Internal drainage	F
	11					 IN + OUT + external	K
						 IN + OUT + internal	L
						 Single inlet	M
						 Flange drainage	P

Displacement		Standard bodies	
TYPE	CODE	Displacement cm3/rev	Standard threads
XV-OR/0.17	01	0.17	B - B Z - Z
XV-OR/0.25	02	0.25	B - B Z - Z
XV-OR/0.45	04	0.45	B - B Z - Z
XV-OR/0.57	05	0.57	B - B Z - Z
XV-OR/0.76	06	0.76	B - B Z - Z
XV-OR/0.98	07	0.98	B - B Z - Z
XV-OR/1.27	09	1.27	B - B Z - Z
XV-OR/1.52	11	1.52	B - B Z - Z
XV-OR/2.30	13	2.30	B - B Z - Z

Table showing standard flange and thread combinations available in stock

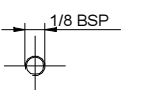
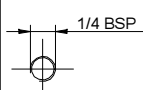
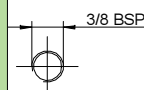
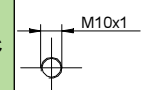
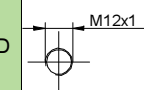
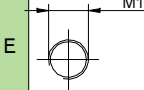
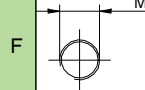
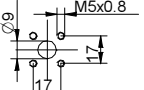
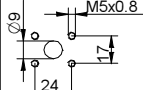
Body (threads/flanges)													
	A		B		C		D		E		F		G
	H		I	Closed Body		Z							