

MDS

5 MPa (50 bar)

Port sizes: 3/4" - 1" - 1 1/4" - 1 1/2"

Flow rates: 50 ÷ 420 l/min

TECHNICAL DATA

Working pressure: 5 MPa (50 bar)

Fatigue test: 0 ÷ 5 MPa (50 bar) / 1.000.000 cycles

Elements collapse differential pressure: 1 MPa (10 bar)

Working temperature: -25 ÷ +110°C

MATERIALS

Head: aluminium alloy

Bowl: steel

Seals: standard NBR
on request FKM

COMPATIBILITY (ISO 2943:1999)

Full with fluids: HH-HL-HM-HV-HTG

(according to ISO 6743/4).

For fluids different than the above mentioned,
please contact our Sales Department.

All tests performed according
to the following standards:

ISO 2941: Element collapse resistance test

ISO 2942: Production integrity test

ISO 2943: Fluids compatibility

ISO 3723: End load test method

ISO 3724: Flow fatigue resistance method

ISO 3968: Pressure drop versus flow rate

ISO 16889: Multipass test.

For further information contact our Technical Dept.

MDS	Type	205	210	220	310	Type	CDS
------------	------	-----	-----	-----	-----	------	------------

Filter media						Filter media	
FT = 5µm _(c)	Fiber β>1000	FT	FT	FT	FT	FT = 5µm _(c)	Fiber β>1000
FC = 7µm _(c)		FC	FC	FC	FC	FC = 7µm _(c)	
FD = 12µm _(c)		FD	FD	FD	FD	FD = 12µm _(c)	
FS = 16µm _(c)		FS	FS	FS	FS	FS = 16µm _(c)	
FV = 21µm _(c)		FV	FV	FV	FV	FV = 21µm _(c)	
CD = 10µ	Paper β>2	CD	CD	CD	CD	CD = 10µ	Paper β>2
CV = 25µ		CV	CV	CV	CV	CV = 25µ	
MV = 25µ	Wire mesh	MV	MV	MV	MV	MV = 25µ	Wire mesh
MS = 60µ		MS	MS	MS	MS	MS = 60µ	
MN = 90µ		MN	MN	MN	MN	MN = 90µ	

Seals						Seals	
1 = NBR Nitrile		1	1	1	1	1 = NBR Nitrile	
2 = FPM Fluoroelastomer		2	2	2	2	2 = FPM Fluoroelastomer	

Bypass type					
S = Without		S	S	S	S
D = Bypass 350 kPa (3,5 bar)		D	D	D	D

B	Ports				
	B = BSP	B	B	B	B

Port size					
4 = 3/4"		4	4	4	-
5 = 1"		5	5	5	-
6 = 1" 1/4		-	-	-	6
7 = 1" 1/2		-	-	-	7

Indicators					
00 = No indicator port		00	00	00	00
03 = Port, plugged		03	03	03	03
5D = Visual differential 250 kPa (2,5 bar)		5D	5D	5D	5D
6D = Electrical differential 250 kPa (2,5 bar)		6D	6D	6D	6D
7D = Electrical differential + LED 250 kPa (2,5 bar)		7D	7D	7D	7D
76 = Visual Electrical differential 250 kPa (2,5 bar)		76	76	76	76
X6 = Electrical differential 250 kPa (2,5 bar)		X6	X6	X6	X6

When the filter is ordered with FKM seals, the first digit of the indicator code is a letter (please see page 188-189).

Accessories					
S = No indicator port		S	S	S	S
A = Indicator port side A (see dwg)		A	A	A	A
B = Indicator port side B (see dwg)		B	B	B	B
C = Indicator port on the top (see dwg)		C	C	C	C

X	Accessories				
	X = Not available	X	X	X	X

DIMENSIONAL LAYOUT

(mm)

MDS 2 ...

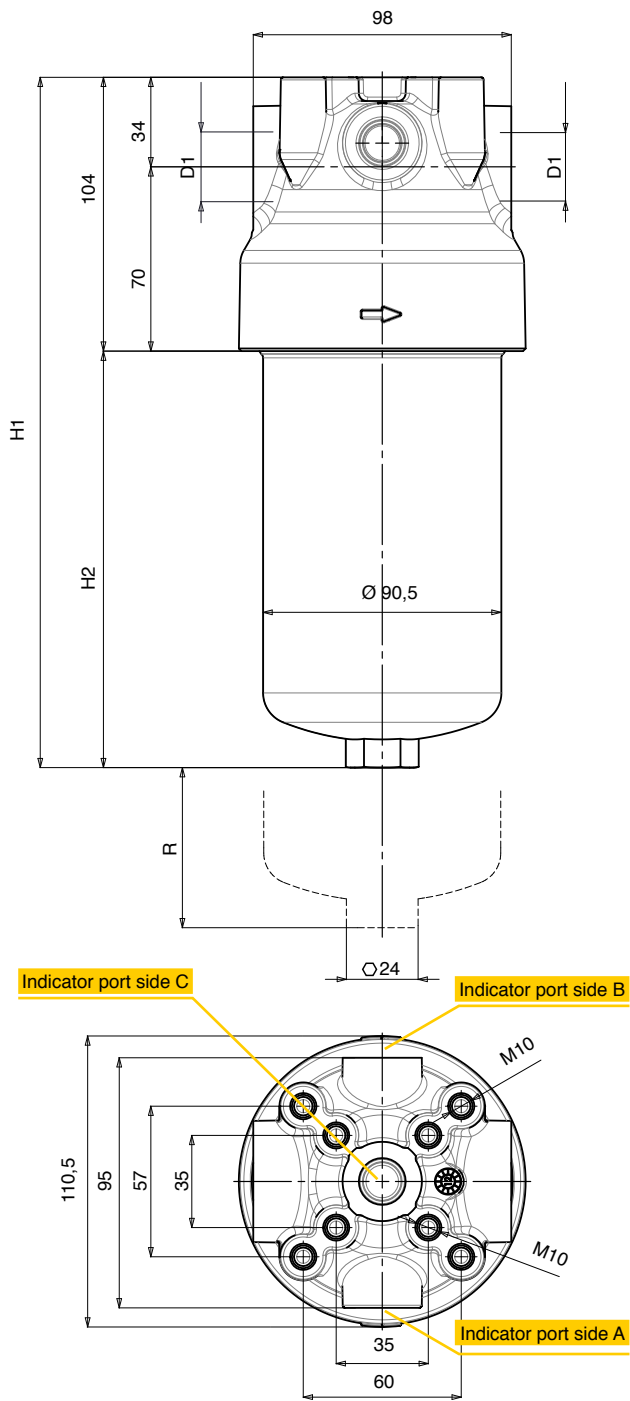

MDS 3 ...

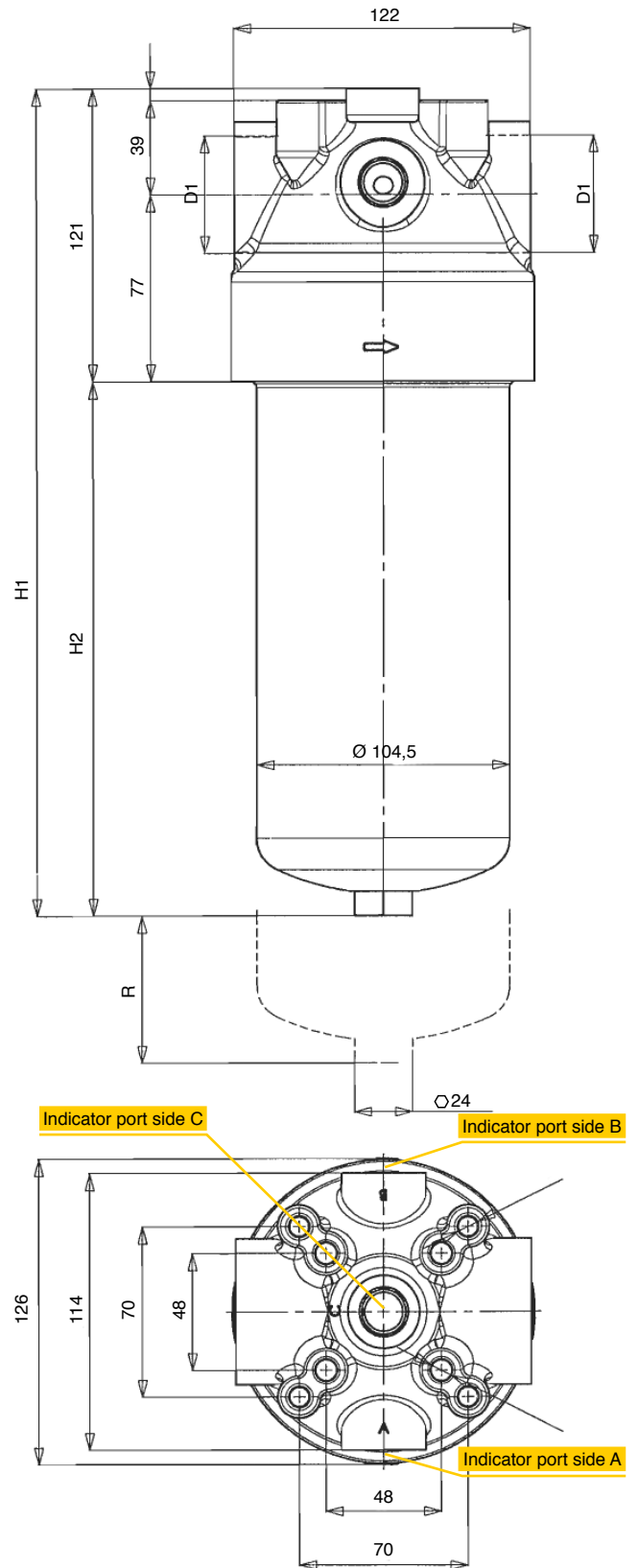

Type	D1	H1	H2	R	Weight Kg
MDS 205	3/4" - 1"	202	98	70	2,00
MDS 210	3/4" - 1"	262	158	70	2,25
MDS 220	3/4" - 1"	342	238	70	2,80
MDS 310	1" 1/4 - 1" 1/2	341	220	70	3,50

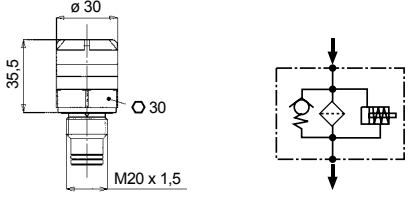
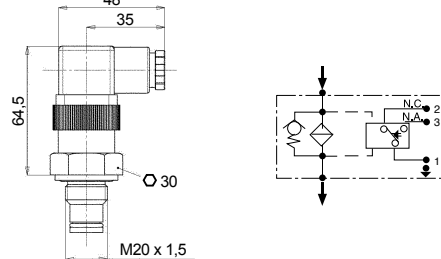
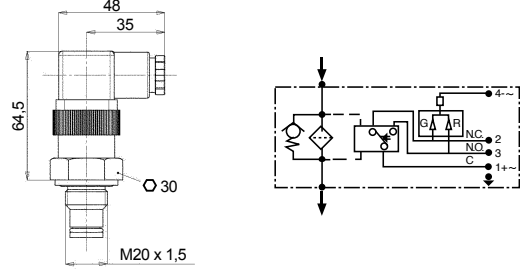
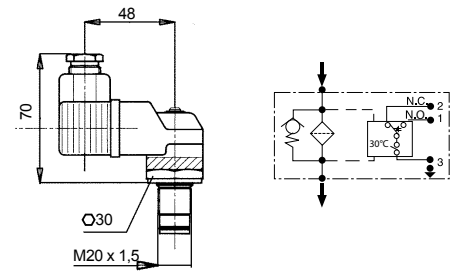
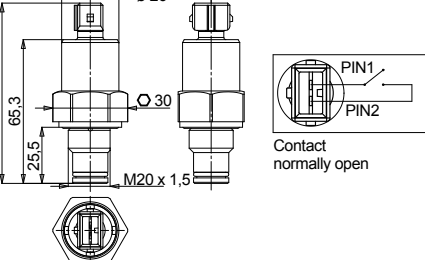
<p>NBR</p> <p>FKM</p> <p>5D</p> <p>AD</p>	<p>Differential VISUAL indicator</p> <p>Setting 250 kPa (2,5 bar)</p>	<p>Recommended tightening torque 90 Nm</p> 
<p>NBR</p> <p>FKM</p> <p>6D</p> <p>CD</p>	<p>Differential ELECTRICAL indicator</p> <p>Setting 250 kPa (2,5 bar)</p> <p>SPDT differential switch. C.C. 14 - 30 V: > max resistive or inductive load 4 - 3 A respectively C.A. 125-250 V: > max resistive or inductive load 1 A - Protection IP65 - Connector DIN 43650</p>	<p>Recommended tightening torque 90 Nm</p> 
<p>NBR</p> <p>FKM</p> <p>7D</p> <p>ED</p>	<p>Differential ELECTRICAL indicator with LED (24V) for visual indication</p> <p>Setting 250 kPa (2,5 bar)</p> <p>SPDT differential switch. C.C. 14 - 30 V: > max resistive or inductive load 4 - 3 A respectively C.A. 125-250 V: > max resistive or inductive load 1 A - Protection IP65 - Connector DIN 43650</p>	<p>Recommended tightening torque 90 Nm</p> 
<p>NBR</p> <p>FKM</p> <p>76</p> <p>E6</p>	<p>Differential VISUAL ELECTRICAL indicator</p> <p>Setting 250 kPa (2,5 bar)</p> <p>SPDT differential switch. C.C. 14 - 30 V: > max resistive or inductive load 4 - 3 A respectively C.A. 125-250 V: > max resistive or inductive load 1 A - Protection IP65 - Connector DIN 43650</p>	<p>Recommended tightening torque 90 Nm</p> 
<p>NBR</p> <p>FKM</p> <p>X6</p> <p>-</p>	<p>Differential ELECTRICAL indicator</p> <p>Setting 250 kPa (2,5 bar)</p> <p>N.O. differential switch. C.C. 28-48V: > max resistive or inductive load 5 - 3A respectively C.A. 125-250 V: > max resistive or inductive load 4A - Protection IP65-IP69K - Connector AMP timer</p>	<p>Recommended tightening torque 54 Nm</p>  <p>Contact normally open</p>

FLOW RATES

(l/min)

Type	Filter Media	Δp 80 kPa (0,8 bar)	Type	Filter Media	Δp 80 kPa (0,8 bar)
MDS 205	FT	55	MDS 220	FT	90
	FC	70		FC	130
	FD	80		FD	150
	FS	85		FS	150
	FV	90		FV	150
	CD	105		CD	150
	CV	115		CV	150
	RD	130		RD	150
	MV	130		MV	150
	MS	150		MS	150
	MN	150		MN	150
MDS 210	FT	80	MDS 310	FT	260
	FC	105		FC	270
	FD	120		FD	310
	FS	125		FS	340
	FV	130		FV	360
	CD	150		CD	400
	CV	150		CV	400
	RD	150		RD	400
	MV	150		MV	400
	MS	150		MS	400
	MN	150		MN	400

The reference fluid has a kinematic viscosity of 30 cSt and a density of 0,86 Kg/dm³.
For different oil viscosity please contact our Sales Department for further information.

DIRT HOLDING CAPACITY(g) ISO MTD $\Delta p = 500$ kPa (5 bar)

Type	Filter Media				
	FT	FC	FD	FS	FV
CDS 205	10,5	12,3	14,4	18,0	22,7
CDS 210	17,3	20,4	24,0	30,0	37,9
CDS 220	26,7	31,4	37,0	44,0	56,8
CDS 310	28,0	36,2	40,5	49,0	58,8

FILTER AREA(cm²)

Type	Filter Media					
	CD	CV	RD	MV	MS	MN
CDS 205	1500	1500	1000	1000	1000	1000
CDS 210	2550	2550	1700	1700	1700	1700
CDS 220	3900	3900	2600	2600	2600	2600
CDS 310	5100	5100	3500	3500	3500	3500